



GÜVEN

ELEKTRİK ELEKTRONİK LTD. ŞTİ.

GWEST®
www.gwest.com.tr

WOER®
www.woer.com.tr



OCAK 2020
FİYAT LİSTESİ



GÜVEN
ELEKTRİK ELEKTRONİK LTD. ŞTİ.

Whatsapp Sipariş Destek Hattı
+90 850 303 77 62
www.guvenelektrik.com.tr

Başarılar Karşılıklı **GÜVEN**'e Bağlıdır.

Şirketimiz 2004 yılında kurulmuş olup kurulduğu tarihten bugüne ithalatlarına her sene üzerine ekleyerek devam etmektedir. Genç ve dinamik yapısı ile müşterilerinin ihtiyaçlarına hızlı, etkili ve pratik çözümler sunmaktadır. Bugün'e kadar çalışmış olduğu müşterilerine koşulsuz müşteri memnuniyeti yaşatan Güven Elektrik hizmetlerine kalite standartlarını yükselterek devam etmektedir.

Firmamıza ait olan tescilli GWEST, WOER, FLK markaları ile siz değerli müşterilerimize 16 yıllık tecrübe ve müşteri memnuniyetini ilke edinerek hizmet vermekten mutluluk duyuyoruz.

WOER[®]
www.woer.com.tr

GWEST[®]
www.gwest.com.tr

FLK[®]
www.flk.com.tr



İÇİNDEKİLER

Kablo Bağları ve Aksesuarları

Standart Beyaz Kablo Bağları	02
Standart Siyah Kablo Bağları	03
Standart Renkli Kablo Bağları	04
Ultraviyole Kablo Bağları	05
Paslanmaz Çelik Kablo Bağları	06
Paslanmaz Çelik Etiket	06
PVC Kaplı Paslanmaz Çelik Kablo Bağları	07
Etiketli Kablo Bağları	08
Açılabilir Kablo Bağları	08
Distanslı Kablo Bağları	08
Yapışkanlı Kroşeler	09
Kapama Parçası	09
Kablo Kelepçesi	09
Kartuş Yükseltici	10
Beton Kroşe	10
Vidalı Kroşe	10
Kablo Bağı Etiket Taşıyıcı	11
Pano Etiket Taşıyıcı	11
Kablo İşaretleme Sistemleri	11
Helezon Spiraller	12

Kablo Yüksükleri ve Papuçları

İzoleli Kablo Yüksükleri Fransız Normu	14
İzoleli Kablo Yüksükleri Alman Normu	15
Çift Girişli Kablo Yüksükleri Fransız Normu	16
Çift Girişli Kablo Yüksükleri Alman Normu	17
İzolesiz Kablo Yüksükleri	18
Yuvarlak Tip İzoleli Kablo Uçları	20
Çatal Tip İzoleli Kablo Uçları	21
Ek Mufları İzoleli Kablo Uçları	22
Erkek Terminalleri İzoleli Kablo Uçları	22
Dişi Terminaller İzoleli Kablo Uçları	22
Dişi Faston Tip İzoleli Kablo Uçları	23
Tam İzoleli Dişi Faston Tip Kablo Uçları	23
Tam İzoleli Polyamid Dişi Faston Tip Kablo Uçları	23
İğne Tip İzoleli Kablo Uçları	24
Erkek / Dişi Geri Dönüşlü Terminaller	24
Dişi Terminaller İzoleli Kablo Uçları	24
Erkek Faston Tip Terminaller	25
Vidalı Buat Klemensleri	25
Hızlı Kablo Ekleme Parçası	25
İzolesiz Kablo Ucu ve Konnektörleri	26

Bağlantı Elemanları

SKP-E Ekonomik Tip Kablo Papucu	28
SKP-S Standart Tip Kablo Papucu	29
Ek Mufları	30
U Klemens	31
Montaj Rayları	31
Monofaze Müşterek W Otomat Baraları	33
Trifaze Müşterek W Otomat Baraları	33
2 Kutulu Dağıtıcı Üniteler	34
4 Kutulu Dağıtıcı Üniteler	35
Tek Kutuplu Dağıtıcı Üniteler	36
Tek Kutuplu Dağıtıcı Üniteler	37
Nötr Vidalı Topraklama Baraları	38
Bara Mesnedi	38
80 A. Modüler Nötr Klemensleri	38
125 A. Kutuplu Dağıtım Ünitesi (7x12mm)	38
160 A. Kutuplu Dağıtım Ünitesi (10x15mm)	38
63 A. Pano Topraklama Klemensleri (6x8mm)	39
80 A. Pano Topraklama Klemensleri (6.5x9mm)	39
125 A. Pano Topraklama Klemensleri (7x12mm)	39
1 Metre Pano Topraklama Klemensleri	39
80 A. Ayaklı Pano Nötr Klemensleri (6.5x9mm)	40
125 A. Ayaklı Pano Nötr Klemensleri (7x12mm)	40
160 A. Ayaklı Pano Nötr Klemensleri (10x15mm)	40
80 A. Ayaksız Pano Nötr Klemensleri (6.5x9mm)	41
125 A. Ayaksız Pano Nötr Klemensleri (7x12mm)	41
160 A. Ayaksız Pano Nötr Klemensleri (10x15mm)	41
Plastik Nötr Ayağı	41

Kompakt Çok Amaçlı Klemensler

Geçmeli Buat Klemens	43
Çok Amaçlı Klemens	43

Makaron Grubu ve Bant Çeşitleri

Isı ile Daralan Siyah Makaronlar	45
Isı ile Daralan Renkli Makaronlar	46
Isı ile Daralan Renkli Makaronlar	47
Isı ile Daralan Sarı / Yeşil Makaronlar	48
İçi Yapışkanlı Daralan Makaronlar	49
Kablo Toplama Çorabı	51
H Class Cam Elyaf Silikon İzoleli Makaronlar	52
PVC İzoleli Cam Elyaf Makaronlar	53
Eriyen Bantlar.....	54
İzole Bantlar	54
Sıcak Hava Tabancası	54

İÇİNDEKİLER

Mekanik ve Hidrolik El Aletleri

Yüksük Sıkma Penseleri	56
İzolesiz Kablo Ucu ve Konnektör Sıkma Penseleri	57
İzoleli Kablo Ucu ve Konnektör Sıkma Penseleri	58
Konnektör Sıkma Penseleri	58
Multi Fonksiyonel Yüksük ve Kablo Ucu Sıkma Pensesi	58
Kablo Sıyırıcılar	59
Kablo Bağı Sıkma Penseleri	59
Kablo Papucu Sıkma Penseleri	60
Hidrolik Sıkma ve Kesme Penseleri	60
Kablo Kesme Makasları	61

Buton Serisi ve Aksesuarları

Yaylı Butonlar	63
İşaretleli Yaylı Butonlar	63
Işıklı Yaylı Butonlar	63
Kalıcı Mandal Butonlar	64
Kayıcı Mandal Butonlar	64
Kalıcı - Kayıcı Mandal Butonlar	64
Anahtarlı Kalıcı Butonlar	64
Işıklı Mandal Butonlar	65
40mm Kalıcı Mantar Butonlar	66
40mm Kalıcı Anahtarlı Mantar Butonlar	66
40mm Kayıcı Mantar Butonlar	66
40mm Kalıcı Mantar Butonlar	66
İkiz Butonlar	67
Buton Aksesuarları	68
Boş Kumanda Kutuları	69
Kutulu Acil Stop Buton	69
Ø 22mm Voltmetre	70
Ø 22mm Ampermetre	70
Ø 22mm Led'li Sinyaller	71
Ø 16mm Led'li Sinyaller	71
BA9S Led Ampuller	72
Metal Led'li Sinyaller	73
Ø 22mm Led'li Buzzer	74
Ø 22mm Ses'li Buzzer	74
Motorlu Sirenler	74
Elektronik Sirenler	74
Ø 22mm Potansiyometre	75
Pano İçi Termostatlar	75
Aks Serisi Kapı Siviçleri	75
Vinç Kumanda Butonları	76

Switch Grubu

GLS Serisi Limit Switch	78
GLS Serisi Limit Switch	79
GLS Serisi Limit Switch	80
GLS Serisi Limit Switch	81
AZ Serisi Mikro Switch	82
AZ Serisi Mikro Switch	83
AZ Serisi Mikro Switch	84
GMS Serisi Mikro Switch	85

Ayak Pedalları

Metal Döküm Pedal	87
Alüminyum Döküm Pedal	87



Bu fiyat listesindeki tipografik baskı hatalarından firmamız sorumlu değildir.

Firmamız fiyat listesinde yayınlanmış olduğu teknik özellikleri değiştirme, döviz ve hammadde artışlarından dolayı meydana gelebilecek fiyat artışlarını hiçbir uyarıda bulunmaksızın fiyat listesine yansıtma hakkına sahiptir.



GÜVEN
ELEKTRİK ELEKTRONİK LTD. ŞTİ.

KABLO BAĞLARI ve AKSESUARLAR



www.guvenelektrik.com.tr

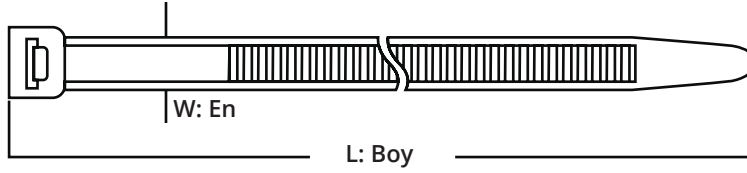

Malzeme :

Saf Naylon 6.6 Standart UL

Çalışma Sıcaklığı :

- 40 ° C --- +85 ° C

STANDART BEYAZ KABLO BAĞLARI

Sipariş Kodu	Ürün Kodu	Boyutlar		Renk	Maksimum Sıkma Çapı (mm)	Açılma Mukavemeti (kg)	Ambalaj Adet		Birim Fiyat TL / Adet
		Uzunluk (mm)	En (mm)				Paket	Koli	
1001	GT 100 M	100	2.5	Beyaz	20	8	1.000	70.000	0.033
1002	GT 150 M	150		Beyaz	36		1.000	55.000	0.050
1003	GT 200 M	200		Beyaz	52		1.000	32.000	0.066
1004	GT 150 I	150	3.6	Beyaz	36	18	100	30.000	0.080
1005	GT 200 I	200		Beyaz	52		100	20.000	0.108
1006	GT 250 I	250		Beyaz	68		100	20.000	0.135
1007	GT 300 I	300		Beyaz	84		100	17.000	0.167
1008	GT 370 I	370		Beyaz	106		100	12.000	0.203
1009	GT 200 ST	200	4.8	Beyaz	50	22	100	16.000	0.145
1010	GT 250 ST	250		Beyaz	65		100	12.000	0.195
1011	GT 300 ST	300		Beyaz	81		100	11.000	0.225
1012	GT 370 ST	370		Beyaz	104		100	9.000	0.285
1050	GT 400 ST	400		Beyaz	113		100	6.500	0.320
1013	GT 430 ST	430		Beyaz	123		100	7.500	0.360
1014	GT 530 ST	530		Beyaz	160		100	5.000	0.485
1015	GT 300 HD	300	7.6	Beyaz	76	55	100	5.000	0.435
1016	GT 370 HD	370		Beyaz	102		100	4.000	0.520
1017	GT 430 HD	430		Beyaz	110		100	2.500	0.650
1018	GT 530 HD	530		Beyaz	140		100	2.000	0.800
1019	GT 610 HD	610		Beyaz	185		100	2.000	0.900
1020	GT 750 HD	750		Beyaz	226		100	2.000	1.150
1022	GT 710 HD	710	9	Beyaz	190	80	100	2.000	1.300
1023	GT 780 HD	780		Beyaz	228		100	2.000	1.450
1024	GT 920 HD	920		Beyaz	280		100	1.000	1.650
1025	GT 1020 HD	1020		Beyaz	295		100	1.000	1.850
1026	GT 1220 HD	1220		Beyaz	375		100	1.000	2.400

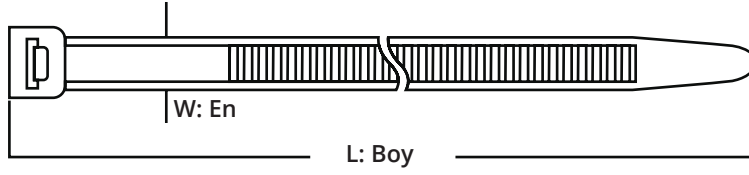
Malzeme :

Saf Naylon 6.6 Standart UL

Çalışma Sıcaklığı :

- 40 ° C --- +85 ° C

STANDART SİYAH KABLO BAĞLARI

Sipariş Kodu	Ürün Kodu	Boyutlar		Renk	Maksimum Sıkma Çapı (mm)	Açılma Mukavemeti (kg)	Ambalaj Adet		Birim Fiyat TL / Adet
		Uzunluk (mm)	En (mm)				Paket	Koli	
1027	GT 100 MB	100	2.5	Siyah	20	8	1.000	70.000	0.033
1028	GT 150 MB	150		Siyah	36		1.000	55.000	0.050
1029	GT 200 MB	200		Siyah	52		1.000	32.000	0.066
1030	GT 150 IB	150	3.6	Siyah	36	18	100	30.000	0.080
1031	GT 200 IB	200		Siyah	52		100	20.000	0.108
1032	GT 250 IB	250		Siyah	68		100	20.000	0.135
1033	GT 300 IB	300		Siyah	84		100	17.000	0.167
1034	GT 370 IB	370		Siyah	106		100	12.000	0.203
1035	GT 200 STB	200	4.8	Siyah	50	22	100	16.000	0.145
1036	GT 250 STB	250		Siyah	65		100	12.000	0.195
1037	GT 300 STB	300		Siyah	81		100	11.000	0.225
1038	GT 370 STB	370		Siyah	104		100	9.000	0.285
1039	GT 430 STB	430		Siyah	123		100	7.500	0.360
1040	GT 530 STB	530		Siyah	160		100	5.000	0.485
1041	GT 300 HDB	300	7.6	Siyah	76	55	100	5.000	0.435
1042	GT 370 HDB	370		Siyah	102		100	4.000	0.520
1043	GT 430 HDB	430		Siyah	110		100	2.500	0.650
1044	GT 530 HDB	530		Siyah	140		100	2.000	0.800
1045	GT 610 HDB	610		Siyah	185		100	2.000	0.900
1048	GT 710 HDB	710	9	Siyah	190	80	100	2.000	1.300
1049	GT 780 HDB	780		Siyah	228		100	2.000	1.450

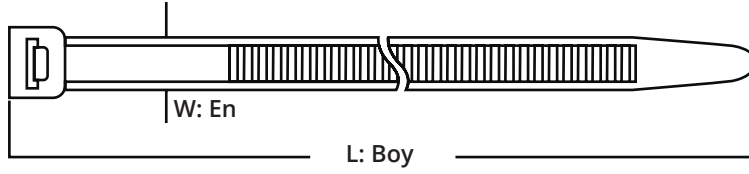
Malzeme :

Saf Naylon 6.6 Standart UL

Çalışma Sıcaklığı :

- 40 °C --- +85 °C

STANDART RENKLİ KABLO BAĞLARI

Sipariş Kodu	Ürün Kodu	Boyutlar		Renk	Maksimum Sıkma Çapı (mm)	Açılma Mukavemeti (kg)	Ambalaj Adet		Birim Fiyat TL / Adet
		Uzunluk (mm)	En (mm)				Paket	Koli	
1101	GT 100 MK	100	2.5	Kırmızı	20	8	1.000	70.000	0.038
1102	GT 150 IK	150	3.6	Kırmızı	36	18	100	30.000	0.090
1103	GT 200 IK	200		Kırmızı	52		100	20.000	0.125
1104	GT 250 IK	250		Kırmızı	68		100	20.000	0.155
1105	GT 300 IK	300		Kırmızı	84		100	17.000	0.190
1106	GT 200 STK	200	4.8	Kırmızı	50	22	100	16.000	0.165
1107	GT 250 STK	250		Kırmızı	65		100	12.000	0.225
1108	GT 300 STK	300		Kırmızı	81		100	11.000	0.265
1109	GT 370 STK	370		Kırmızı	101		100	9.000	0.335
1110	GT 100 MM	100	2.5	Mavi	20	8	1.000	70.000	0.038
1111	GT 150 IM	150	3.6	Mavi	36	18	100	30.000	0.090
1112	GT 200 IM	200		Mavi	52		100	20.000	0.125
1113	GT 250 IM	250		Mavi	68		100	20.000	0.155
1114	GT 300 IM	300		Mavi	84		100	17.000	0.190
1115	GT 200 STM	200	4.8	Mavi	50	22	100	16.000	0.165
1116	GT 250 STM	250		Mavi	65		100	12.000	0.225
1117	GT 300 STM	300		Mavi	81		100	11.000	0.265
1118	GT 370 STM	370		Mavi	101		100	9.000	0.335
1119	GT 100 MS	100	2.5	Sarı	20	8	1.000	70.000	0.038
1120	GT 150 IS	150	3.6	Sarı	36	18	100	30.000	0.090
1121	GT 200 IS	200		Sarı	52		100	20.000	0.125
1122	GT 250 IS	250		Sarı	68		100	20.000	0.155
1123	GT 300 IS	300		Sarı	84		100	17.000	0.190
1124	GT 200 STS	200	4.8	Sarı	50	22	100	16.000	0.165
1125	GT 250 STS	250		Sarı	65		100	12.000	0.225
1126	GT 300 STS	300		Sarı	81		100	11.000	0.265
1127	GT 370 STS	370		Sarı	104		100	9.000	0.335
1128	GT 100 MY	100	2.5	Yeşil	20	8	1.000	70.000	0.038
1129	GT 150 IY	150	3.6	Yeşil	36	18	100	30.000	0.090
1130	GT 200 IY	200		Yeşil	52		100	20.000	0.125
1131	GT 250 IY	250		Yeşil	68		100	20.000	0.155
1132	GT 300 IY	300		Yeşil	84		100	17.000	0.190
1133	GT 200 STY	200	4.8	Yeşil	50	22	100	16.000	0.165
1134	GT 250 STY	250		Yeşil	65		100	12.000	0.225
1135	GT 300 STY	300		Yeşil	81		100	11.000	0.265
1136	GT 370 STY	370		Yeşil	101		100	9.000	0.335

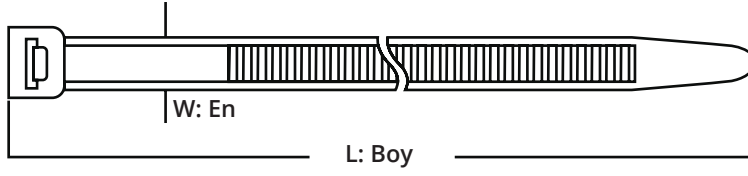

Malzeme :

Saf Nylon 6.6 Standart UL

Çalışma Sıcaklığı :

- 40 ° C --- +85 ° C

ULTRAVIOLE KABLO BAĞLARI

Sipariş Kodu	Ürün Kodu	Boyutlar		Renk	Maksimum Sıkma Çapı (mm)	Açılma Mukavemeti (kg)	Ambalaj Adet		Birim Fiyat TL / Adet
		Uzunluk (mm)	En (mm)				Paket	Koli	
1201	GT 100 M UV	100	2.5	Siyah	20	8	1.000	70.000	0.037
1202	GT 150 M UV	150		Siyah	36		1.000	55.000	0.060
1203	GT 200 M UV	200		Siyah	52		1.000	32.000	0.085
1204	GT 150 I UV	150	3.6	Siyah	36	18	100	30.000	0.095
1205	GT 200 I UV	200		Siyah	52		100	20.000	0.130
1206	GT 250 I UV	250		Siyah	68		100	20.000	0.175
1207	GT 300 I UV	300		Siyah	84		100	17.000	0.200
1208	GT 200 ST UV	200	4.8	Siyah	50	22	100	16.000	0.175
1209	GT 250 ST UV	250		Siyah	65		100	12.000	0.230
1210	GT 300 ST UV	300		Siyah	81		100	11.000	0.290
1211	GT 370 ST UV	370		Siyah	104		100	9.000	0.360
1212	GT 430 ST UV	430		Siyah	123		100	7.500	0.410
1213	GT 300 HD UV	300	7.6	Siyah	76	55	100	5.000	0.490
1214	GT 370 HD UV	370		Siyah	102		100	4.000	0.600
1215	GT 430 HD UV	430		Siyah	110		100	2.500	0.750
1216	GT 530 HD UV	530		Siyah	140		100	2.000	0.980
1217	GT 780 HD UV	780	9	Siyah	228	80	100	2.000	1.700



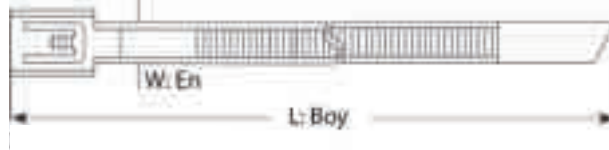

Malzeme : 304 Paslanmaz Çelik
Su emilimi : Yok
Alev yürmeme : UL94V-2

PASLANMAZ ÇELİK KABLO BAĞLARI

Sipariş Kodu	Ürün Kodu	Boyutlar		Renk	Maksimum Sıkma Çapı (mm)	Açılma Mukavemeti (kg)	Ambalaj Adet		Birim Fiyat TL / Adet
		Uzunluk (mm)	En (mm)				Paket	Koli	
1301	MTL 150 ST	150	4.6	Metal	44	55	100	8.000	0.820
1302	MTL 200 ST	200		Metal	51		100	6.000	0.930
1303	MTL 260 ST	260		Metal	69		100	5.000	1.020
1304	MTL 300 ST	300		Metal	76		100	5.000	1.100
1305	MTL 370 ST	370		Metal	102		100	4.000	1.230
1306	MTL 520 ST	520		Metal	152		100	3.000	1.450
1307	MTL 680 ST	680		Metal	203		100	2.000	2.000
1308	MTL 840 ST	840		Metal	254		100	1.000	2.400
1309	MTL 200 HD	200	7.9	Metal	50	120	100	5.000	1.450
1310	MTL 300 HD	300		Metal	75		100	4.000	1.600
1311	MTL 370 HD	370		Metal	102		100	3.000	1.750
1312	MTL 520 HD	520		Metal	152		100	2.000	2.200
1313	MTL 680 HD	680		Metal	203		100	2.000	2.700
1314	MTL 840 HD	840		Metal	224		100	1.000	3.300

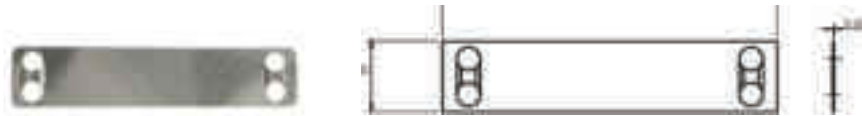

Malzeme : 304 Paslanmaz Çelik
Su emilimi : Yok
Alev yürmeme : UL94V-2

PASLANMAZ ÇELİK ETİKET

Sipariş Kodu	Ürün Kodu	Açıklama	Renk	Boy ve Genişlik (mm)	Ambalaj Adet	Birim Fiyat TL / Adet
1351	MTL PE	Paslanmaz Çelik Etiket	Metal	19x90mm	100	1.100

Paslanmaz Çelik Kablo Bağları

- Kendiliğinden kilitlenebilir kafa tasarımı, kurulumu hızlandırır ve kablo bağı gövdesi boyunca herhangi bir boyda kilitlemeyi sağlar.
- Güçlü ve dayanıklı kablo bağlama yöntemini temin eder.
- Çok çeşitli iç mekân ve dış mekân uygulama alanlarında kullanılabilir.
- Pürüzsüz yüzeyi ve yuvarlatılmış uçları ile kablonun korunmasını ve çalışan kişinin güvenliğini garanti eder.
- Şebeke kablolarında en üst düzey desteği sağlar.
- Genel amaçlı uygulamalar için : 304 paslanmaz çelik

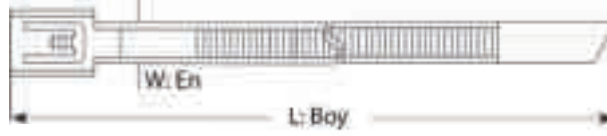

Malzeme : 304 Paslanmaz Çelik
Su emilimi : Yok
Alev yürmeme : UL94V-2

PVC KAPLI PASLANMAZ ÇELİK KABLO BAĞLARI

Sipariş Kodu	Ürün Kodu	Boyutlar		Renk	Maksimum Sıkma Çapı (mm)	Açılma Mukavemeti (kg)	Ambalaj Adet		Birim Fiyat TL / Adet
		Uzunluk (mm)	En (mm)				Paket	Koli	
1401	PVC MTL 150 ST	150	4.6	Metal	44	55	100	8.000	1.050
1402	PVC MTL 200 ST	200		Metal	51		100	6.000	1.150
1403	PVC MTL 260 ST	260		Metal	69		100	5.000	1.250
1404	PVC MTL 300 ST	300		Metal	76		100	5.000	1.500
1405	PVC MTL 370 ST	370		Metal	102		100	4.000	1.600
1406	PVC MTL 520 ST	520		Metal	152		100	3.000	1.950
1407	PVC MTL 680 ST	680		Metal	203		100	2.000	2.650
1408	PVC MTL 840 ST	840		Metal	254		100	1.000	3.600
1409	PVC MTL 200 HD	200	7.9	Metal	50	120	100	5.000	1.650
1410	PVC MTL 300 HD	300		Metal	75		100	4.000	1.950
1411	PVC MTL 370 HD	370		Metal	102		100	3.000	2.300
1412	PVC MTL 520 HD	520		Metal	152		100	2.000	2.900
1413	PVC MTL 680 HD	680		Metal	203		100	2.000	3.800
1414	PVC MTL 840 HD	840		Metal	224		100	1.000	4.700

PVC Kaplı Paslanmaz Çelik Kablo Bağları

- Kendiliğinden kilitlenebilir kafa tasarımı, kurulumu hızlandırır ve kablo bağı gövdesi boyunca herhangi bir boyda kilitlemeyi sağlar.
- Güçlü ve dayanıklı kablo bağlama yöntemini temin eder.
- Çok çeşitli iç mekân ve dış mekân uygulama alanlarında kullanılabilir.
- Pürüzsüz yüzeyi ve yuvarlatılmış uçları ile kablounun korunmasını ve çalışan kişinin güvenliğini garanti eder.
- Şebeke kablolarında en üst düzey desteği sağlar.
- Genel amaçlı uygulamalar için : 304 paslanmaz çelik



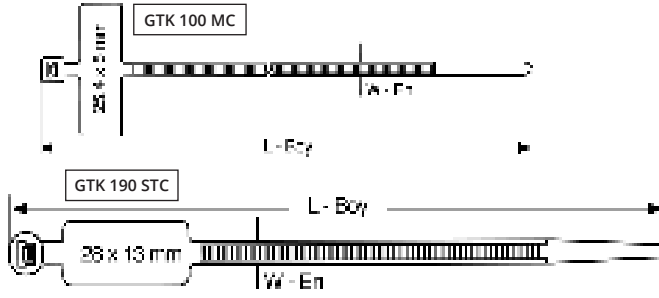

Malzeme :

Saf Naylon 6.6 Standart UL

Çalışma Sıcaklığı :

- 40 °C --- +85 °C

ETİKETLİ KABLO BAĞLARI

Sipariş Kodu	Ürün Kodu	Boyutlar		Renk	Maksimum Sıkma Çapı (mm)	Açılma Mukavemeti (kg)	Ambalaj Adet		Birim Fiyat TL / Adet
		Uzunluk (mm)	En (mm)				Paket	Koli	
1501	GTK 100 MC	100	2.5	Beyaz	20	8	100	30.000	0.098
1502	GTK 190 STC	190	4.8	Beyaz	48	22	100	12.000	0.250

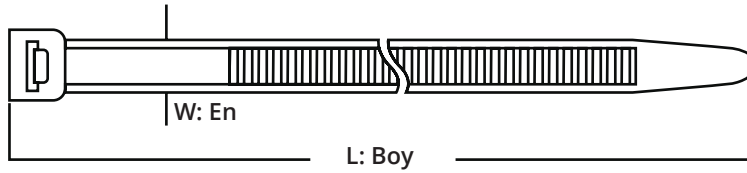

Malzeme :

Saf Naylon 6.6 Standart UL

Çalışma Sıcaklığı :

- 40 °C --- +85 °C

AÇILABİLİR KABLO BAĞLARI

Sipariş Kodu	Ürün Kodu	Boyutlar		Renk	Maksimum Sıkma Çapı (mm)	Açılma Mukavemeti (kg)	Ambalaj Adet		Birim Fiyat TL / Adet
		Uzunluk (mm)	En (mm)				Paket	Koli	
1503	GTA 200 HD	200	7.6	Beyaz	50	36	100	5.000	0.350
1504	GTA 370 HD	370	7.6	Beyaz	100	36	100	3.000	0.570

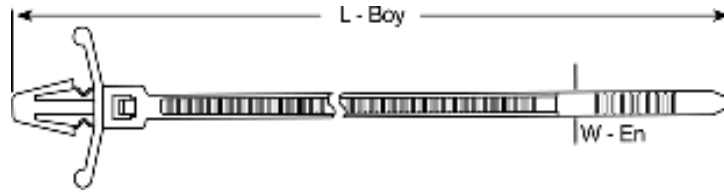

Malzeme :

Saf Naylon 6.6 Standart UL

Çalışma Sıcaklığı :

- 40 °C --- +85 °C

DİSTANSLI KABLO BAĞLARI

Sipariş Kodu	Ürün Kodu	Boyutlar		Renk	Maksimum Sıkma Çapı (mm)	Açılma Mukavemeti (kg)	Ambalaj Adet		Birim Fiyat TL / Adet
		Uzunluk (mm)	En (mm)				Paket	Koli	
1505	GTP 100 M	100	2.5	Beyaz	20	8	100	50.000	0.088
1506	GTP 150 I	150	3.6	Beyaz	35	18	100	30.000	0.145
1507	GTP 200 ST	200	4.8	Beyaz	50	22	100	12.000	0.270

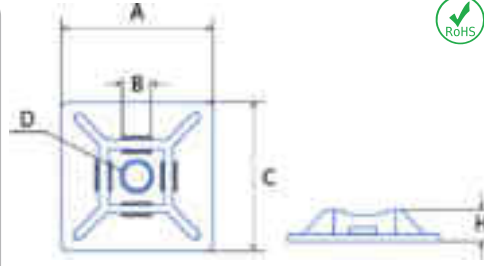

Malzeme :

Saf Naylon 6.6 Standart UL

Çalışma Sıcaklığı :

- 40 ° C --- +85 ° C

YAPIŞKANLI KROŞELER

Sipariş Kodu	Ürün Kodu	Boyutlar					Renk	Ambalaj Adet		Birim Fiyat TL / Adet
		A	B	C	D	H		Paket	Koli	
1513	HW - 3A	19	19	3.6	Ø 3.2	4.0	Beyaz	100	20.000	0.190
1514	HW - 4A	28	28	4.8	Ø 3.2	4.5	Beyaz	100	9.000	0.350
1515	HW - 3AB	19	19	3.6	Ø 3.2	4.0	Siyah	100	20.000	0.190
1516	HW - 4AB	28	28	4.8	Ø 3.2	4.5	Siyah	100	9.000	0.350

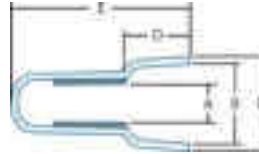
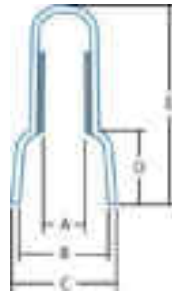

Malzeme :

Saf Naylon 6.6 Standart UL

Çalışma Sıcaklığı :

105 ° C --- +300 ° C

Modeli:

600 Volt Enerjiye Dayanabilme

KAPAMA PARÇASI

Sipariş Kodu	Ürün Kodu	Boyutlar					Renk	Ambalaj Adet		Birim Fiyat TL / Adet
		A	B	C	D	H		Paket	Koli	
1517	HW - C4	19	19	3.6	Ø 3.2	4.0	Beyaz	100	20.000	0.090
1518	HW - C5	28	28	4.8	Ø 3.2	4.5	Beyaz	100	9.000	0.150

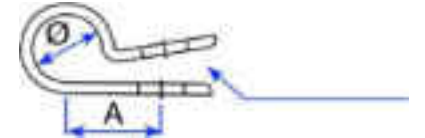
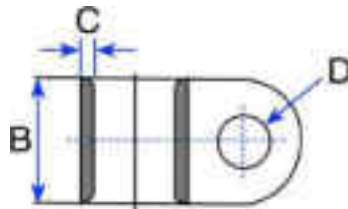

KABLO KELEPÇESİ

Sipariş Kodu	Ürün Kodu	Boyutlar						Renk	Ambalaj Adet		Birim Fiyat TL / Adet
		Ø	Ø 1	A	B	C	D		Paket	Koli	
1523	GCL 1/4	7.4	6.6	10.3	9.1	1.27	M5	Beyaz	100	30.000	0.160
1524	GCL 3/8	10.9	9.7	11.9	9.2	1.27	M5	Beyaz	100	20.000	0.210

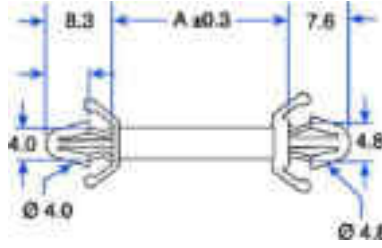
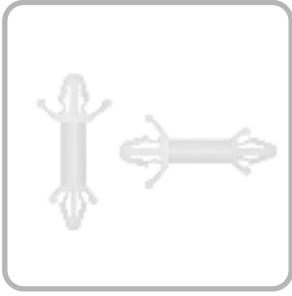

Malzeme :

Saf Naylon 6.6 Standart UL

Çalışma Sıcaklığı :

- 40 ° C --- +85 ° C

KARTUŞ YÜKSELTİCİ

Sipariş Kodu	Ürün Kodu	Boyutlar		Renk	Ambalaj Adet		Birim Fiyat TL / Adet
		A			Paket	Koli	
1519	CBS - 9A	9.2		Beyaz	1.000	40.000	0.200
1520	CBS - 13A	12.6		Beyaz	1.000	30.000	0.210
1521	CBS - 16A	15.8		Beyaz	1.000	25.000	0.230

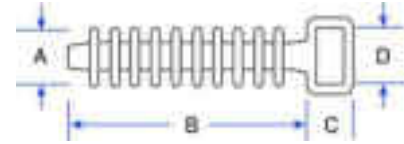

BETON KROŞE

Sipariş Kodu	Ürün Kodu	Boyutlar				Maksimum Sıkma Çapı (mm)	Renk	Ambalaj Adet		Birim Fiyat TL / Adet
		A	B	C	D			Paket	Koli	
1525	TH - 2	9.5	36.0	6.0	9.5	9.5	Siyah	100	8.000	0.250

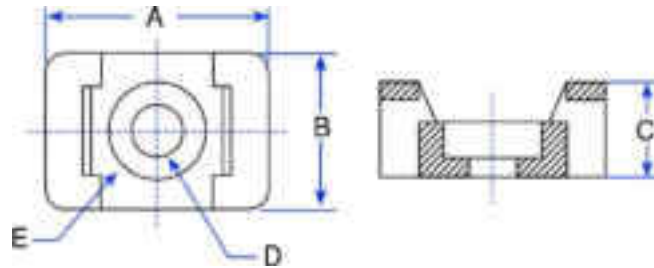

VİDALI KROŞE

Sipariş Kodu	Ürün Kodu	Boyutlar					Maksimum Sıkma Çapı (mm)	Renk	Ambalaj Adet		Birim Fiyat TL / Adet
		A	B	C	D	E			Paket	Koli	
1511	VK V - 1	14.9	9.5	6.9	4.5	7.8	4.8	Beyaz	100	5.000	0.140
1512	VK V - 2	22.2	15.9	9.7	6.4	12.6	7.6	Beyaz	100	5.000	0.200

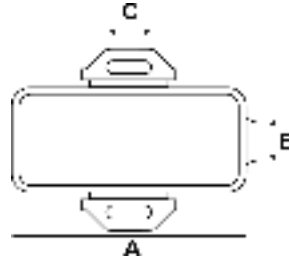

Malzeme :

Polipropilen

Çalışma Sıcaklığı :

0 °C --- +90 °C

KABLO BAĞI ETİKET TAŞIYICI

Sipariş Kodu	Ürün Kodu	Boyutlar			Etiket Eni (mm)	Etiket Boyu (mm)	Renk	Ambalaj Adet		Birim Fiyat TL / Adet
		A	B	C				Paket	Koli	
1526	GET - 1	35	10	8	32	7	Beyaz	100	12.500	0.450
1527	GET - 2	45	20	8	42	17	Beyaz	100	6.000	0.710



Malzeme :

ABS Altlık, PS Kapak + Çift Taraflı Bant

Çalışma Sıcaklığı :

-40 °C --- +60 °C

YAPIŞKANLI PANO ETİKET TAŞIYICI

Sipariş Kodu	Ürün Kodu	Boyutlar		Etiket Eni (mm)	Etiket Boyu (mm)	Renk	Ambalaj Adet		Birim Fiyat TL / Adet
		A	B				Paket	Koli	
1528	GPET - 1	30	17	27.5	14.4	Siyah	100	12.000	0.580
1529	GPET - 2	50	17	49	15	Siyah	50	6.000	0.800
1530	GPET - 3	75	17	72	15	Siyah	25	5.000	1.100

KABLO İŞARETLEME SİSTEMLERİ



BASKI NUMARASI	EC-0		EC-1		EC-2	
	KESİT: 0.50-1mm Kablolar için MAKARA : 1000 Ad.		KESİT: 1.50-6m Kablolar için MAKARA : 1000 Ad.		KESİT: 4-16mm Kablolar için MAKARA :500 Ad.	
	Sipariş Kodu	Fiyat	Sipariş Kodu	Fiyat	Sipariş Kodu	Fiyat
0	1601	23 TL	1611	23 TL	1621	23 TL
1	1602		1612		1622	
2	1603		1613		1623	
3	1604		1614		1624	
4	1605		1615		1625	
5	1606		1616		1626	
6	1607		1617		1627	
7	1608		1618		1628	
8	1609		1619		1629	
9	1610		1620		1630	

HELEZON SPİRALLER

Sipariş Kodu	Ürün Kodu	O.D.	T	W	Kablo Kesit (mm ²)	Renk	Paket Miktarı (Mt.)	Koli Miktarı (Mt.)	Birim Fiyat TL / Mt.
3251	GHS6 (No1)	6	0.60	7.4	2.5 - 15	Beyaz	10	1.000	1.00
3252	GHS8 (No2)	8	0.75	12	6 - 30	Beyaz	10	800	1.30
3253	GHS10 (No3)	10	0.80	12.3	7.5 - 30	Beyaz	10	500	2.00
3254	GHS12 (No4)	12	0.85	15	9 - 32	Beyaz	10	400	2.80
3255	GHS15 (No5)	15	1.00	15.5	12 - 35	Beyaz	10	250	3.60

Malzeme : PE

Esnek yapısı sayesinde kabloların düzenlemesine yardımcı olur
Güçlü yapısı sayesinde tekrar kullanım için uygundur

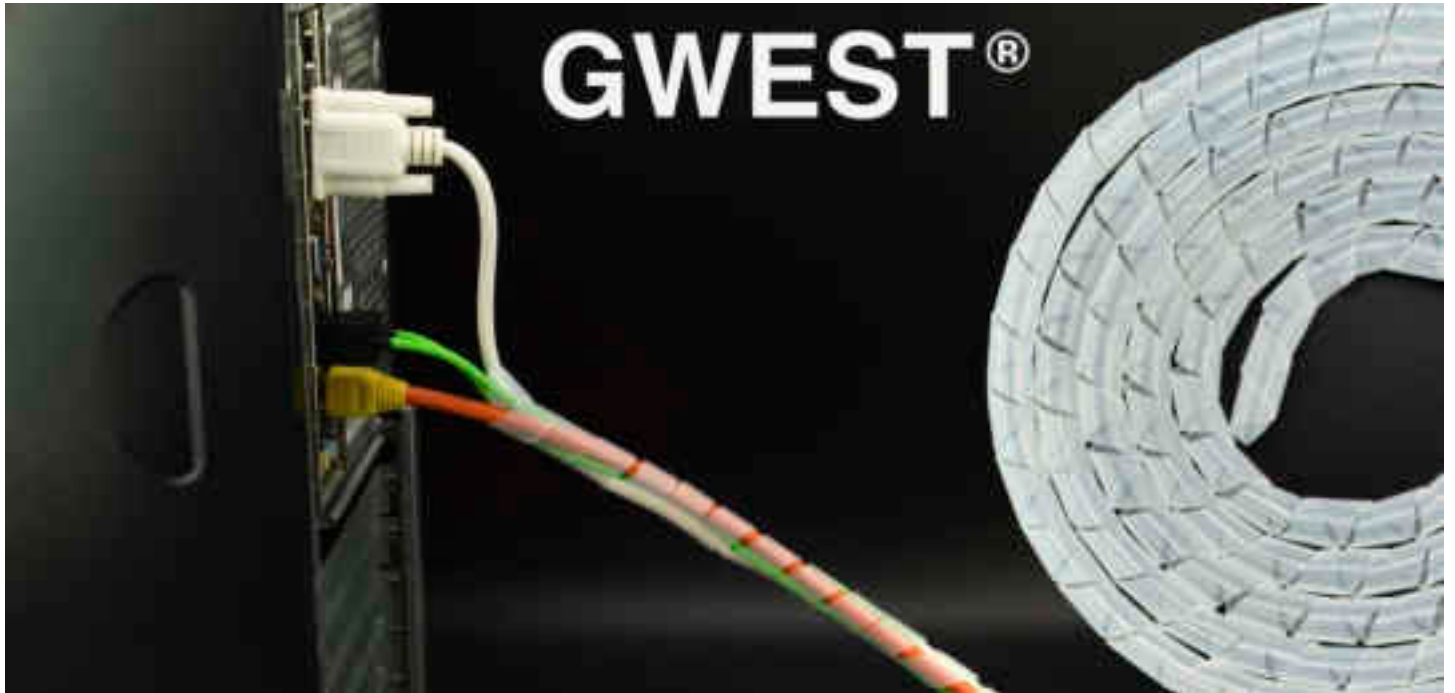
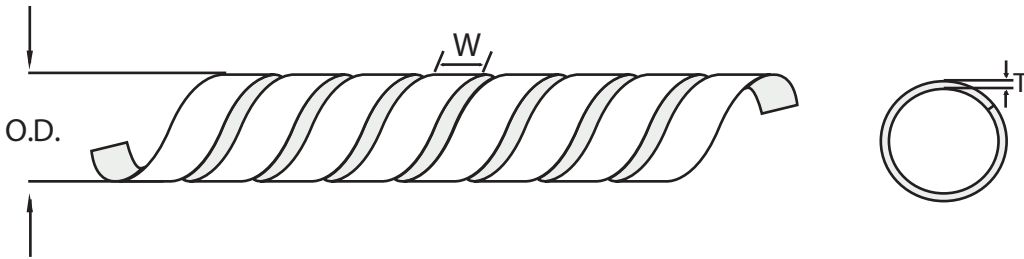



GÜVEN
ELEKTRİK ELEKTRONİK LTD. ŞTİ.

KABLO YÜKSÜKLERİ ve PAPUÇLARI



www.guvenelektrik.com.tr









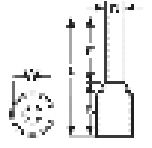







İZOLELİ KABLO YÜKSÜKLERİ FRANSIZ NORMU



Standart : DIN 46228
Malzeme : Bakır, Kalay Kaplı
İzolasyon : Naylon
Çalışma Sıcaklığı : Maksimum 105° 600Volt Arası



Sipariş Kodu	Ürün Kodu	Renk	Kablo Kesit (mm ²)	Ebatlar (mm)					Kutu Adet	Birim Fiyat TL / Adet
				F	L	W	B	D		
2001	IYF - 0.25	 Menekşe	0.25 mm ²	8.0	12.0	1.9	4.4	1.1	1.000	0.073
2002	IYF - 0.34	 Pembe	0.34 mm ²	8.0	12.0	1.9	4.4	1.1	1.000	0.073
2003	IYF - 0.50	 Beyaz	0.50 mm ²	8.0	14.0	2.6	6.0	1.3	1.000	0.034
2004	IYF - 0.75	 Mavi	0.75 mm ²	8.0	14.0	2.8	6.3	1.5	1.000	0.034
2005	IYF - 1.0	 Kırmızı	1.00 mm ²	8.0	14.0	3.0	6.3	1.7	1.000	0.034
2006	IYF - 1.5	 Siyah	1.50 mm ²	8.0	14.0	3.5	6.3	2.0	1.000	0.039
2007	IYF - 2.5	 Gri	2.50 mm ²	8.0	14.0	4.2	7.4	2.5	500	0.048
2008	IYF - 4.0	 Turuncu	4.00 mm ²	10.0	17.0	4.8	7.4	3.2	500	0.084
2009	IYF - 6.0	 Yeşil	6.00 mm ²	12.0	20.0	6.3	8.5	3.9	250	0.110
2010	IYF - 10.0	 Kahve	10.0 mm ²	12.0	22.0	7.6	8.8	4.9	100	0.140
2011	IYF - 16.0	 Bej	16.0 mm ²	12.0	24.0	8.8	10.0	6.2	100	0.200
2012	IYF - 25.0	 Siyah	25.0 mm ²	16.0	28.0	11.2	12.0	7.7	50	0.390
2013	IYF - 35.0	 Kırmızı	35.0 mm ²	16.0	30.0	12.7	14.0	8.7	50	0.470
2014	IYF - 50.0	 Mavi	50.0 mm ²	20.0	36.0	15.0	16.0	10.9	25	0.900
2015	IYF - 70.0	 Sarı	70.0 mm ²	21.0	37.0	16.0	17.0	14.3	25	1.700









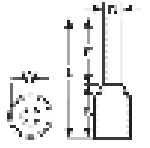







İZOLELİ KABLO YÜKSÜKLERİ ALMAN NORMU



Standart : DIN 46228
Malzeme : Bakır, Kalay Kaplı
İzolasyon : Naylon
Çalışma Sıcaklığı : Maksimum 105° 600Volt Arası



Sipariş Kodu	Ürün Kodu	Renk	Kablo Kesit (mm ²)	Ebatlar (mm)					Kutu Adet	Birim Fiyat TL / Adet
				F	L	W	B	D		
2101	IYA - 0.14	 Gri	0.14 mm ²	8.0	12.0	1.6	2.8	0.9	1.000	0.073
2102	IYA - 0.25	 Mavi	0.25 mm ²	8.0	12.0	1.9	4.4	1.1	1.000	0.073
2103	IYA - 0.34	 Turkuaz	0.34 mm ²	8.0	12.0	1.9	4.4	1.1	1.000	0.073
2104	IYA - 0.50	 Turuncu	0.50 mm ²	8.0	14.0	2.6	6.0	1.3	1.000	0.034
2105	IYA - 0.75	 Beyaz	0.75 mm ²	8.0	14.0	2.8	6.3	1.5	1.000	0.034
2106	IYA - 1.0	 Sarı	1.00 mm ²	8.0	14.0	3.0	6.3	1.7	1.000	0.034
2107	IYA - 1.5	 Kırmızı	1.50 mm ²	8.0	14.0	3.5	6.3	2.0	1.000	0.039
2108	IYA - 2.5	 Mavi	2.50 mm ²	8.0	14.0	4.2	7.4	2.5	500	0.048
2109	IYA - 4.0	 Gri	4.00 mm ²	10.0	17.0	4.8	7.4	3.2	500	0.084
2110	IYA - 6.0	 Siyah	6.00 mm ²	12.0	20.0	6.3	8.5	3.9	250	0.110
2111	IYA - 10.0	 Bej	10.0 mm ²	12.0	22.0	7.6	8.8	4.9	100	0.140
2112	IYA - 16.0	 Yeşil	16.0 mm ²	12.0	24.0	8.8	10.0	6.2	100	0.200
2113	IYA - 25.0	 Kahve	25.0 mm ²	16.0	28.0	11.2	12.0	7.7	50	0.390
2114	IYA - 35.0	 Bej	35.0 mm ²	16.0	30.0	12.7	14.0	8.7	50	0.470
2115	IYA - 50.0	 Yeşil	50.0 mm ²	20.0	36.0	15.0	16.0	10.9	25	0.900









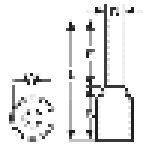

ÇİFT GİRİŞLİ KABLO YÜKSÜKLERİ FRANSIZ NORMU



Standart : DIN 46228
Malzeme : Bakır, Kalay Kaplı
İzolasyon : Naylon
Çalışma Sıcaklığı : Maksimum 105° 600Volt Arası



Sipariş Kodu	Ürün Kodu	Renk	Kablo Kesit (mm ²)	Ebatlar (mm)					Kutu Adet	Birim Fiyat TL / Adet
				F	L	W	B	D		
2201	CYF - 0.50	 Beyaz	0.50 mm ²	8.0	14.0	5.0	6.5	1.8	1.000	0.067
2202	CYF - 0.75	 Mavi	0.75 mm ²	8.0	14.0	5.5	6.7	2.1	500	0.067
2203	CYF - 1.0	 Kırmızı	1.00 mm ²	8.0	14.0	5.5	7.1	2.4	500	0.075
2204	CYF - 1.5	 Siyah	1.50 mm ²	8.0	14.0	6.4	7.5	2.6	500	0.090
2205	CYF - 2.5	 Gri	2.50 mm ²	10.0	14.0	8.0	8.5	3.3	250	0.132
2206	CYF - 4.0	 Turuncu	4.00 mm ²	12.0	17.0	8.0	11.1	4.2	200	0.170
2207	CYF - 6.0	 Yeşil	6.00 mm ²	14.0	20.0	9.5	12.1	5.3	100	0.230
2208	CYF - 10.0	 Kahve	10.0 mm ²	14.0	27.0	12.6	12.6	6.9	50	0.335
2209	CYF - 16.0	 Bej	16.0 mm ²	14.0	31.0	19.0	17.3	8.7	50	0.430









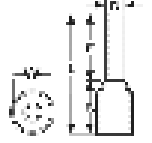

ÇİFT GİRİŞLİ KABLO YÜKSÜKLERİ ALMAN NORMU



Standart : DIN 46228
Malzeme : Bakır, Kalay Kaplı
İzolasyon : Naylon
Çalışma Sıcaklığı : Maksimum 105° 600Volt Arası



Sipariş Kodu	Ürün Kodu	Renk	Kablo Kesit (mm ²)	Ebatlar (mm)					Kutu Adet	Birim Fiyat TL / Adet
				F	L	W	B	D		
2301	CYA - 0.50	 Turuncu	0.50 mm ²	8.0	14.0	5.0	6.5	1.8	1.000	0.067
2302	CYA - 0.75	 Beyaz	0.75 mm ²	8.0	14.0	5.5	6.7	2.1	500	0.067
2303	CYA - 1.0	 Sarı	1.00 mm ²	8.0	14.0	5.5	7.1	2.4	500	0.075
2304	CYA - 1.5	 Kırmızı	1.50 mm ²	8.0	14.0	6.4	7.5	2.6	500	0.090
2305	CYA - 2.5	 Mavi	2.50 mm ²	10.0	14.0	8.0	8.5	3.3	250	0.132
2306	CYA - 4.0	 Gri	4.00 mm ²	12.0	17.0	8.0	11.1	4.2	200	0.170
2307	CYA - 6.0	 Siyah	6.00 mm ²	14.0	20.0	9.5	12.1	5.3	100	0.230
2308	CYA - 10.0	 Bej	10.0 mm ²	14.0	27.0	12.6	12.6	6.9	50	0.335
2309	CYA - 16.0	 Yeşil	16.0 mm ²	14.0	31.0	19.0	17.3	8.7	50	0.430

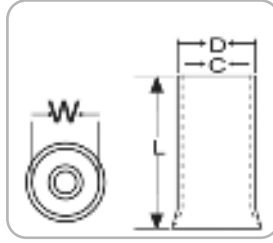

**Standart** : DIN 46228**Malzeme** : Bakır, Kalay Kaplı

İZOLESİZ KABLO YÜKSÜKLERİ

Sipariş Kodu	Ürün Kodu	Kablo Kesit (mm ²)	Ebatlar (mm)				Kutu Adet	Birim Fiyat TL / Adet
			L	W	D	C		
2401	KY - 0.50	0.50 mm ²	10	2.1	1.3	1.0	2.000	0.034
2402	KY - 0.75	0.75 mm ²	10	2.3	1.5	1.2	1.000	0.034
2403	KY - 1.0	1.00 mm ²	10	2.5	1.7	1.4	1.000	0.034
2404	KY - 1.5	1.50 mm ²	10	2.8	2.0	1.7	1.000	0.038
2405	KY - 2.5	2.50 mm ²	12	3.4	2.5	2.2	1.000	0.055
2406	KY - 4.0	4.00 mm ²	12	4.0	3.2	2.8	1.000	0.080
2407	KY - 6.0	6.00 mm ²	12	4.7	3.9	3.5	500	0.105
2408	KY - 10.0	10.0 mm ²	15	5.8	4.9	4.5	250	0.160
2409	KY - 16.0	16.0 mm ²	15	7.5	6.2	5.8	250	0.240
2410	KY - 25.0	25.0 mm ²	16	9.1	7.9	7.5	100	0.310
2411	KY - 35.0	35.0 mm ²	16	10.2	8.7	8.3	100	0.360
2412	KY - 50.0	50.0 mm ²	22	12.7	10.9	10.3	50	0.700



GWEST®

KABLO UÇLARI



YUVARLAK TİP İZOLELİ KABLO UÇLARI

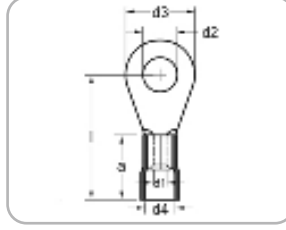

Standart : DIN 46237
Malzeme : Bakır, Kalay Kaplı
İzolasyon : PVC
Çalışma Sıcaklığı : Maksimum 105° 600Volt Arası

Sipariş Kodu	Ürün Kodu	Renk	Kablo Kesit (mm ²)	Civata Ölçüsü	Ebatlar (mm)						Kutu Adet	Birim Fiyat TL / Adet
					d2	d3	l	d1	d4	a		
3001	GYU - 301	Kırmızı	0.50 - 1.50 mm ²	M3	3.2	6.0	16.0	1.6	4.0	10.0	200	0.100
3003	GYU - 401	Kırmızı		M4	4.3	8.0	17.0	1.6	4.0	10.0	200	0.155
3004	GYU - 501	Kırmızı		M5	5.3	10.0	18.0	1.6	4.0	10.0	200	0.160
3005	GYU - 601	Kırmızı		M6	6.5	10.0	18.0	1.6	4.0	10.0	200	0.250
3006	GYU - 801	Kırmızı		M8	8.4	14.0	22.0	1.6	4.0	10.0	200	0.260
3007	GYU - 302	Mavi	1.50 - 2.50 mm ²	M3	3.2	6.0	16.0	2.3	4.5	10.0	200	0.190
3008	GYU - 402	Mavi		M4	4.3	8.0	17.0	2.3	4.5	10.0	200	0.195
3009	GYU - 502	Mavi		M5	5.3	10.0	19.0	2.3	4.5	10.0	200	0.200
3010	GYU - 602	Mavi		M6	6.5	11.0	20.0	2.3	4.5	10.0	200	0.275
3011	GYU - 802	Mavi		M8	8.4	14.0	22.0	2.3	4.5	10.0	200	0.280
3012	GYU - 1002	Mavi		M10	10.5	15.0	22.0	2.3	4.5	10.0	200	0.300
3013	GYU - 406	Sarı	4.00 - 6.00 mm ²	M4	4.3	8.6	21.0	3.6	6.3	13.0	100	0.400
3014	GYU - 506	Sarı		M5	5.3	10.0	22.0	3.6	6.3	13.0	100	0.410
3015	GYU - 606	Sarı		M6	6.5	11.0	22.5	3.6	6.3	13.0	100	0.460
3016	GYU - 806	Sarı		M8	8.4	14.0	26.0	3.6	6.3	13.0	100	0.600
3017	GYU - 1006	Sarı		M10	10.5	18.0	28.0	3.6	6.3	13.0	100	0.610
3018	GYU - 1206	Sarı		M12	13.0	18.0	28.0	3.6	6.3	13.0	100	0.620
3019	GYU - 610	Kırmızı	8.00 - 10.00 mm ²	M6	6.7	23.5	30.0	4.5	8.0	17.0	50	1.000
3020	GYU - 810	Kırmızı		M8	8.4	26.3	36.0	4.5	8.0	17.0	50	1.100

ÇATAL TİP İZOLELİ KABLO UÇLARI

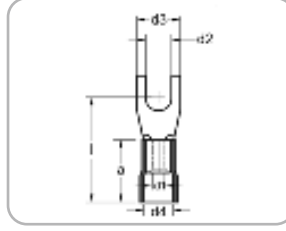

Standart : DIN 46237
Malzeme : Bakır, Kalay Kaplı
İzolasyon : PVC
Çalışma Sıcaklığı : Maksimum 105° 600Volt Arası

Sipariş Kodu	Ürün Kodu	Renk	Kablo Kesit (mm ²)	Civata Ölçüsü	Ebatlar (mm)						Kutu Adet	Birim Fiyat TL / Adet
					d2	d3	l	d1	d4	a		
3101	GÇU - 3001	Kırmızı	0.50 - 1.50 mm ²	M3	3.2	6.0	16.0	1.6	4.0	10.0	200	0.140
3102	GÇU - 4001	Kırmızı		M4	4.3	8.0	17.0	1.6	4.0	10.0	200	0.150
3103	GÇU - 5001	Kırmızı		M5	5.3	10.0	18.0	1.6	4.0	10.0	200	0.160
3104	GÇU - 6001	Kırmızı		M6	6.5	11.0	20.0	1.6	4.0	10.0	200	0.175

3105	GÇU - 3002	Mavi	1.50 - 2.50 mm ²	M4	3.2	5.5	18.0	2.3	4.5	10.0	200	0.155
3106	GÇU - 4002	Mavi		M5	4.3	6.8	17.0	2.3	4.5	10.0	200	0.165
3107	GÇU - 5002	Mavi		M6	5.3	10.0	19.0	2.3	4.5	10.0	200	0.170
3108	GÇU - 6002	Mavi		M8	6.5	11.0	21.0	2.3	4.5	10.0	200	0.220

3109	GÇU - 4006	Sarı	4.00 - 6.00 mm ²	M4	4.3	8.0	21.0	3.6	6.3	13.0	100	0.350
3110	GÇU - 5006	Sarı		M5	5.3	10.0	22.0	3.6	6.3	13.0	100	0.360
3111	GÇU - 6006	Sarı		M6	6.5	11.0	23.0	3.6	6.3	13.0	100	0.480
3112	GÇU - 8006	Sarı		M8	8.4	14.0	26.0	3.6	6.3	13.0	100	0.560

EK MUFLARI İZOLELİ KABLO UÇLARI



Standart : DIN 46237
Malzeme : Bakır, Kalay Kaplı
İzolasyon : PVC
Çalışma Sıcaklığı : Maksimum 75° 300Volt Arası

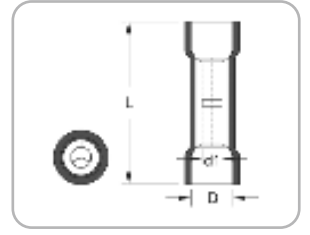

Sipariş Kodu	Ürün Kodu	Renk	Kablo Kesit (mm ²)	Ebatlar (mm)			Kutu Adet	Birim Fiyat TL / Adet
				L	D	d1		
3201	GBY - 251	■ Kırmızı	0.50 - 1.50 mm ²	24.6	4.0	1.7	200	0.230
3202	GBY - 252	■ Mavi	1.50 - 2.50 mm ²	24.6	4.5	2.3	200	0.250
3203	GBY - 256	■ Sarı	4.00 - 6.00 mm ²	26.5	6.3	3.4	100	0.400

ERKEK TERMİNALLER İZOLELİ KABLO UÇLARI



Malzeme : Pirinç, Kalay Kaplı, Bakır Yüksüklü
İzolasyon : PVC
Çalışma Sıcaklığı : Maksimum 75° 300Volt Arası

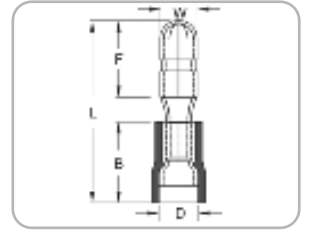

Sipariş Kodu	Ürün Kodu	Renk	Kablo Kesit (mm ²)	Ebatlar (mm)					Kutu Adet	Birim Fiyat TL / Adet
				W	F	L	B	D		
3204	GBE - 1040	■ Kırmızı	0.50 - 1.50 mm ²	4.0	8.5	21.5	10.5	3.8	200	0.400
3205	GBE - 2050	■ Mavi	1.50 - 2.50 mm ²	5.0	8.5	21.2	10.5	4.7	200	0.470
3206	GBE - 5050	■ Sarı	4.00 - 6.00 mm ²	5.0	8.5	24.0	13.0	6.2	200	0.620

DİŞİ TERMİNALLER İZOLELİ KABLO UÇLARI



Malzeme : Pirinç, Kalay Kaplı, Bakır Yüksüklü
İzolasyon : PVC
Çalışma Sıcaklığı : Maksimum 75° 300Volt Arası

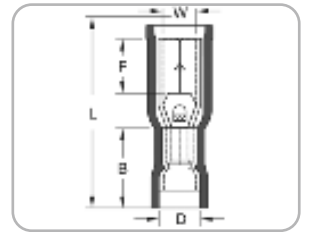

Sipariş Kodu	Ürün Kodu	Renk	Kablo Kesit (mm ²)	Ebatlar (mm)					Kutu Adet	Birim Fiyat TL / Adet
				W	F	L	B	D		
3207	GBD - 1040	■ Kırmızı	0.50 - 1.50 mm ²	3.9	7.0	23.3	10.5	3.8	200	0.480
3208	GBD - 2050	■ Mavi	1.50 - 2.50 mm ²	4.9	7.0	23.3	10.5	4.7	100	0.530
3209	GBD - 5050	■ Sarı	4.00 - 6.00 mm ²	4.9	7.0	25.1	12.5	6.2	100	0.700

DIŞI FASTON TİP İZOLELİ KABLO UÇLARI



Malzeme : Pirinç, Kalay Kaplı
İzolasyon : PVC
Çalışma Sıcaklığı : Maksimum 75° 300Volt Arası

Sipariş Kodu	Ürün Kodu	Renk	Kablo Kesit (mm ²)	Soket Genişliği	Ebatlar (mm)					Kutu Adet	Birim Fiyat TL / Adet
					W	F	L	B	D		
3210	GFD - 1288	■ Kırmızı	0.50 - 1.50 mm ²	0.8 x 2.80	3.2	6.5	19.0	10.5	3.8	200	0.180
3211	GFD - 1488	■ Kırmızı		0.8 x 4.75	5.0	6.4	19.4	10.5	3.8	200	0.220
3212	GFD - 1638	■ Kırmızı		0.8 x 6.35	6.6	7.5	20.8	10.5	3.8	200	0.290
3213	GFD - 2288	■ Mavi	1.50 - 2.50 mm ²	0.8 x 2.80	3.2	6.5	19.0	10.5	4.7	200	0.220
3214	GFD - 2488	■ Mavi		0.8 x 4.75	5.0	6.4	19.4	10.5	4.7	200	0.260
3215	GFD - 2638	■ Mavi		0.8 x 6.35	6.6	7.5	20.8	10.5	4.7	200	0.290
3216	GFD - 5638	■ Sarı	4.00 - 6.00 mm ²	0.8 x 6.35	6.6	7.5	23.3	13.0	6.2	200	0.350

TAM İZOLELİ DIŞI FASTON TİP KABLO UÇLARI

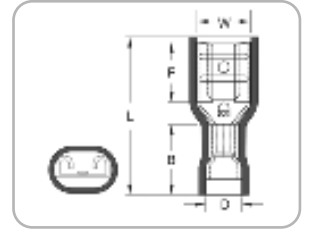

Malzeme : Pirinç, Kalay Kaplı
İzolasyon : PVC
Çalışma Sıcaklığı : Maksimum 75° 300Volt Arası

Sipariş Kodu	Ürün Kodu	Renk	Kablo Kesit (mm ²)	Soket Genişliği	Ebatlar (mm)					Kutu Adet	Birim Fiyat TL / Adet
					W	F	L	B	D		
3218	GFFD - 1288	■ Kırmızı	0.50 - 1.50 mm ²	0.8 x 2.80	3.2	6.5	19.0	10.5	3.8	200	0.270
3219	GFFD - 1488	■ Kırmızı		0.8 x 4.75	5.0	6.4	20.5	10.5	3.8	200	0.270
3220	GFFD - 1638	■ Kırmızı		0.8 x 6.35	6.6	7.5	21.8	10.5	3.8	200	0.380
3221	GFFD - 2288	■ Mavi	1.50 - 2.50 mm ²	0.8 x 2.80	3.2	6.5	20.0	10.5	4.7	200	0.280
3222	GFFD - 2488	■ Mavi		0.8 x 4.75	5.0	6.4	20.2	10.5	4.7	200	0.280
3223	GFFD - 2638	■ Mavi		0.8 x 6.35	6.6	7.5	22.2	10.5	4.7	200	0.380
3224	GFFD - 5638	■ Sarı	4.00 - 6.00 mm ²	0.8 x 6.35	6.6	7.5	24.2	12.5	6.2	100	0.410

TAM İZOLELİ POLYAMİD DIŞI FASTON TİP KABLO UÇLARI

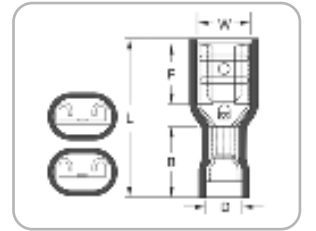

Malzeme : Pirinç, Kalay Kaplı
İzolasyon : Polyamid
Çalışma Sıcaklığı : Maksimum 105° 300Volt Arası

Sipariş Kodu	Ürün Kodu	Renk	Kablo Kesit (mm ²)	Soket Genişliği	Ebatlar (mm)					Kutu Adet	Birim Fiyat TL / Adet
					W	F	L	B	D		
3225	GPFD - 1638	■ Kırmızı	0.50 - 1.50 mm ²	0.8 x 6.35	6.6	7.5	21.5	11.0	4.0	200	0.800
3226	GPFD - 2638	■ Mavi	1.50 - 2.50 mm ²	0.8 x 6.35	6.6	7.5	21.5	11.0	5.0	200	0.800
3227	GPFD - 5638	■ Sarı	4.00 - 6.00 mm ²	0.8 x 6.35	6.6	7.5	24.2	13.0	6.5	100	1.000

İĞNE TİP İZOLELİ KABLO UÇLARI



Malzeme : Bakır, Kalay Kaplı
İzolasyon : PVC
Çalışma Sıcaklığı : Maksimum 75° 300Volt Arası

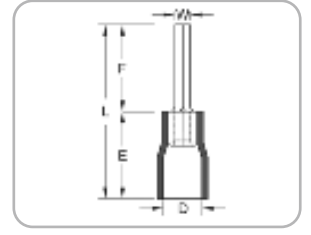

Sipariş Kodu	Ürün Kodu	Renk	Kablo Kesit (mm ²)	Ebatlar (mm)					Kutu Adet	Birim Fiyat TL / Adet
				W	F	L	E	D		
3228	GİK - 101	■ Kırmızı	0.50 - 1.50 mm ²	1.9	10.0	19.0	10.0	4.0	200	0.180
3229	GİK - 102	■ Mavi	1.50 - 2.50 mm ²	1.9	12.0	21.8	10.0	4.5	200	0.210
3230	GİK - 106	■ Sarı	4.00 - 6.00 mm ²	2.8	14.0	27.0	27.0	6.4	100	0.500

ERKEK / DIŞI GERİ DÖNÜŞLÜ TERMİNALER



Malzeme : Pirinç, Kalay Kaplı
İzolasyon : PVC
Çalışma Sıcaklığı : Maksimum 75° 300Volt Arası

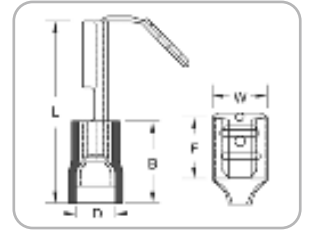

Sipariş Kodu	Ürün Kodu	Renk	Kablo Kesit (mm ²)	Soket Genişliği	Ebatlar (mm)					Kutu Adet	Birim Fiyat TL / Adet
					W	F	L	B	D		
3231	GFDEG - 1861	■ Kırmızı	0.50 - 1.50 mm ²	0.8 x 6.35	6.6	8.0	22.5	10.5	3.8	100	0.500
3232	GFDEG - 2862	■ Mavi	1.50 - 2.50 mm ²	0.8 x 6.35	6.6	8.0	22.5	10.5	4.7	100	0.500
3233	GFDEG - 5866	■ Sarı	4.00 - 6.00 mm ²	0.8 x 6.35	6.6	8.0	24.0	13.0	6.2	100	0.550

DIŞI TERMİNALER İZOLELİ KABLO UÇLARI



Malzeme : Pirinç, Kalay Kaplı
İzolasyon : Polyamid
Çalışma Sıcaklığı : Maksimum 105° 300Volt Arası

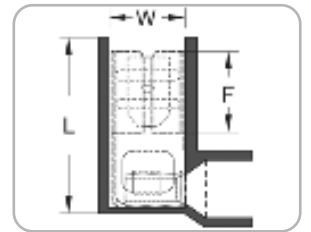

Sipariş Kodu	Ürün Kodu	Renk	Kablo Kesit (mm ²)	Ebatlar (mm)			Kutu Adet	Birim Fiyat TL / Adet
				W	F	L		
3234	GPFDEB - 1861	■ Kırmızı	0.8 x 6.35	6.6	7.6	16.0	100	0.500
3235	GPFDEB - 2862	■ Mavi	0.8 x 6.35	6.6	7.6	16.0	100	0.500

ERKEK FASTON TİP TERMİNALLER



Malzeme : Pirinç, Kalay Kaplı
İzolasyon : PVC
Çalışma Sıcaklığı : Maksimum 75° 300Volt Arası

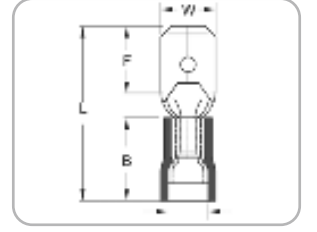

Sipariş Kodu	Ürün Kodu	Renk	Kablo Kesit (mm ²)	Soket Genişliği	Ebatlar (mm)					Kutu Adet	Birim Fiyat TL / Adet
					W	F	L	B	D		
3236	GFE - 1288	Kırmızı	0.50 - 1.50 mm ²	0.8 x 2.80	2.8	6.5	19.2	10.5	3.8	200	0.200
3237	GFE - 1488	Kırmızı		0.8 x 4.75	4.8	6.7	19.8	10.5	3.8	200	0.200
3238	GFE - 1638	Kırmızı		0.8 x 6.35	6.35	6.35	21.8	10.5	3.8	200	0.250
3239	GFE - 2288	Mavi	1.50 - 2.50 mm ²	0.8 x 2.80	2.8	6.7	19.8	10.5	4.7	200	0.200
3240	GFE - 2488	Mavi		0.8 x 4.75	4.8	6.7	19.8	10.5	4.7	200	0.200
3241	GFE - 2638	Mavi		0.8 x 6.35	6.35	7.7	21.8	10.5	4.7	200	0.260
3242	GFE - 5638	Sarı	4.00 - 6.00 mm ²	0.8 x 6.35	6.35	7.7	24.8	13.0	6.2	200	0.300

VİDALI BUAT KLEMENSLERİ



Malzeme : Pirinç, Kalay Kaplı
İzolasyon : PVC
Çalışma Sıcaklığı : Maksimum 75° 300Volt Arası

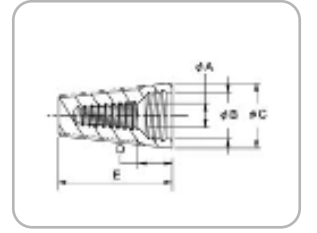

Sipariş Kodu	Ürün Kodu	Renk	Ebatlar (mm)					Kutu Adet	Birim Fiyat TL / Adet
			A	B	C	D	E		
3243	G - 1	Gri	3.8	6.70	8.60	5.80	15.20	1.000	0.170
3244	G - 2	Mavi	4.10	7.00	9.80	5.90	17.60	1.000	0.200
3245	G - 3	Oranj	5.00	9.90	12.20	7.80	22.00	500	0.270
3246	G - 4	Sarı	6.00	11.20	14.00	7.90	24.00	500	0.450
3247	G - 6	Kırmızı	7.50	13.00	16.40	9.15	26.50	500	0.550

HIZLI KABLO EKLEME PARÇASI



Malzeme : Pirinç, Kalay Kaplı
İzolasyon : Naylon
Çalışma Sıcaklığı : Maksimum 105° 600Volt Arası

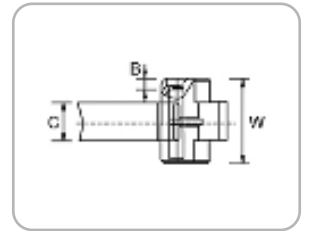







Sipariş Kodu	Ürün Kodu	Renk	Kablo Kesit (mm ²)	Ebatlar (mm)			Kutu Adet	Birim Fiyat TL / Adet
				W	F	L		
3248	GP - 1	Kırmızı	0.50 - 1.00 mm ²	4.0	10.6	20.0	500	0.380
3249	GP - 2	Mavi	1.50 - 2.50 mm ²	4.0	10.6	20.0	500	0.380
3250	GP - 5	Sarı	4.00 - 6.00 mm ²	4.0	2.0	20.0	250	0.600

İZOLESİZ KABLO UCU VE KONNEKTÖRLERİ

					
SİPARİŞ KODU	3301	3302	3303	3305	3304
ÜRÜN KODU	GF1/2D	GF1D MİNİ	GF1D	GF3D	GF2D TRK
AÇIKLAMA	2.8 Mikro Dişi Terminal	4.8 Mini Dişi Terminal	6.3 Dişi Terminal	9.5 Dişi Terminal	6.3 Tırnaklı Dişi Terminal
KUTU ADET	1.000	500	300	100	300
BİRİM FİYAT TL/Ad.	0.068	0.098	0.13	0.31	0.13

					
SİPARİŞ KODU	3306	3307	3320	3321	3309
ÜRÜN KODU	GF1D EĞRİ	GF1D E	GKN 1-03	GKN 1-04	GKN 2.5-04
AÇIKLAMA	6.3 Eğri Dişi Terminal	6.3 Erkek Geri Dönüşümlü Terminal	M3 Topraklama Terminali	M4 Topraklama Terminali	M4 Topraklama Terminali
KUTU ADET	250	200	500	500	500
BİRİM FİYAT TL/Ad.	0.15	0.25	0.098	0.098	0.105

					
SİPARİŞ KODU	3310	3311	3312	3313	3314
ÜRÜN KODU	GKN 2.5-05	GKN 2.5-06	GKN 4-04	GKN 4-05	GKN 4-06
AÇIKLAMA	M5 Topraklama Terminali	M6 Topraklama Terminali	M4 Topraklama Terminali	M5 Topraklama Terminali	M6 Topraklama Terminali
KUTU ADET	500	500	250	250	250
BİRİM FİYAT TL/Ad.	0.105	0.105	0.25	0.25	0.25

					
SİPARİŞ KODU	3315	3316	3318	3325	3326
ÜRÜN KODU	GKN 6-06	GKN 8-08	GKN 10-10	GK 2.5	GK 4
AÇIKLAMA	M6 Topraklama Terminali	M8 Topraklama Terminali	M10 Topraklama Terminali	Boru Tip Topraklama Terminali	Boru Tip Topraklama Terminali
KUTU ADET	150	150	100	1.000	500
BİRİM FİYAT TL/Ad.	0.33	0.33	0.40	0.13	0.22

					
SİPARİŞ KODU	3327	3332	3333	3341	3340
ÜRÜN KODU	GK 6	GF1E ÇK	GF1EU1	R TİPİ KONNEKTÖR	GF1D KILIF
AÇIKLAMA	Boru Tip Topraklama Terminali	6.3 Erkek Terminal	6.3 Uzun Erkek Terminal	6.3 Kilitli Konnektör	6.3 Terminal Kılıfı
KUTU ADET	250	300	300	300	300
BİRİM FİYAT TL/Ad.	0.24	0.13	0.165	0.070	0.062



GÜVEN
ELEKTRİK ELEKTRONİK LTD. ŞTİ.

BAĞLANTI ELEMENLARI



www.guvenelektrik.com.tr



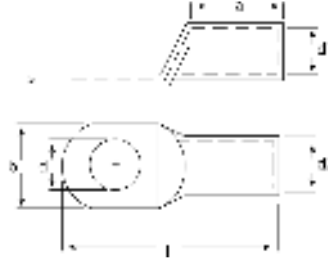

Malzeme : EN13600 Standart Bakır
Yüzey : Kalay

SKP-E EKONOMİK TİP KABLO PAPUCU

Sipariş Kodu	Ürün Kodu	Kablo Kesit (mm ²)	Delik Çapı Ø	Boyutlar						Kutu/Amb. Adet	Birim Fiyat TL / Adet
				d	d1	d2	l	a	b		
3400	SKP-E 16-6	16 mm ²	M6	6.5	5.5	7.0	32.5	11.0	10.5	500	0.91
3401	SKP-E 16-8	16 mm ²	M8	8.5	5.5	7.0	32.5	11.0	10.5	500	0.94
3402	SKP-E 25-6	25 mm ²	M6	6.5	7.0	9.0	38.5	16.0	13.0	400	1.70
3403	SKP-E 25-8		M8	8.5	7.0	9.0	38.5	16.0	13.0	400	1.60
3404	SKP-E 35-6	35 mm ²	M6	6.5	8.5	10.5	43.5	19.0	15.5	300	2.40
3405	SKP-E 35-8		M8	8.3	8.5	10.5	43.5	19.0	15.5	300	2.30
3406	SKP-E 50-8	50 mm ²	M8	8.5	10.0	12.0	51.5	21.0	17.6	200	2.80
3407	SKP-E 50-10		M10	10.5	10.0	12.0	51.5	21.0	17.6	200	2.70
3408	SKP-E 70-10	70 mm ²	M10	10.5	11.5	14.0	55.5	23.0	20.7	100	4.60
3409	SKP-E 70-12		M12	13.0	11.5	14.0	55.5	23.0	20.7	100	4.70
3410	SKP-E 95-10	95 mm ²	M10	10.5	13.5	16.0	58.5	26.0	23.5	75	5.40
3411	SKP-E 95-12		M12	13.0	13.5	16.0	58.5	26.0	23.5	75	5.30
3412	SKP-E 120-10	120 mm ²	M10	10.5	15.5	18.0	71.0	29.0	26.7	50	7.90
3413	SKP-E 120-12		M12	13.0	15.5	18.0	71.0	29.0	26.7	50	7.70
3414	SKP-E 150-10	150 mm ²	M10	10.5	16.5	20.0	76.0	30.0	29.2	40	11.80
3415	SKP-E 150-12		M12	13.0	16.5	20.0	76.0	30.0	29.2	40	11.50
3416	SKP-E 185-12	185 mm ²	M12	13.0	18.5	22.0	82.0	33.0	32.3	30	14.40
3417	SKP-E 185-16		M16	17.0	18.5	22.0	82.0	33.0	32.3	30	14.00
3418	SKP-E 240-12	240 mm ²	M12	13.0	21.5	25.5	91.0	38.0	37.6	25	21.50
3419	SKP-E 240-16		M16	17.0	21.5	25.5	91.0	38.0	37.6	25	21.00

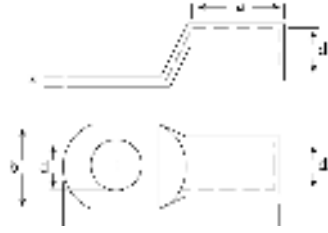

Malzeme : EN13600 Standart Bakır
Yüzey : Kalay

SKP-S STANDART TİP KABLO PAPUCU

Sipariş Kodu	Ürün Kodu	Kablo Kesit (mm ²)	Delik Çapı Ø	Boyutlar									Kutu/Amb. Adet	Birim Fiyat TL / Adet
				d	d1	d2	l	l1	a	b	c1	c2		
3430	SKP-S 10-5	10 mm ²	M5	5.5	4.4	6.0	27.5	21.6	10.0	10.3	6.0	6.0	1.000	1.05
3431	SKP-S 10-6		M6	6.5	4.4	6.0	27.5	21.6	10.0	10.3	6.0	6.0	1.000	1.10
3432	SKP-S 10-8		M8	8.5	4.4	6.0	27.5	21.6	10.0	13.5	6.0	6.0	1.000	1.10
3433	SKP-S 16-6	16 mm ²	M6	6.5	5.5	8.0	32.6	25.0	12.0	11.2	7.0	8.0	500	1.55
3434	SKP-S 16-8		M8	8.5	5.5	8.0	32.6	25.0	12.0	13.7	7.0	8.0	500	1.60
3435	SKP-S 16-10		M10	10.5	5.5	8.0	32.6	25.0	12.0	16.0	7.0	8.0	500	1.70
3436	SKP-S 25-6	25 mm ²	M6	6.5	6.8	9.0	39.0	32.2	16.0	13.5	6.8	9.2	400	2.60
3437	SKP-S 25-8		M8	8.5	6.8	9.0	39.0	32.2	16.0	13.5	6.8	9.2	400	2.50
3438	SKP-S 25-10		M10	10.5	7.0	9.5	42.0	34.0	16.0	16.0	6.8	11.0	300	2.60
3439	SKP-S 35-6	35 mm ²	M6	6.5	8.2	11.0	44.0	35.7	19.0	15.7	8.3	9.7	200	3.60
3440	SKP-S 35-8		M8	8.5	8.2	11.0	44.0	35.7	19.0	15.7	8.3	9.7	200	3.50
3441	SKP-S 35-10		M10	10.5	8.2	11.0	48.0	38.0	19.0	15.7	10.0	12.0	200	3.60
3442	SKP-S 50-8	50 mm ²	M8	8.5	9.5	12.0	47.5	39.2	21.0	17.7	8.3	9.7	150	5.40
3443	SKP-S 50-10		M10	10.5	9.5	12.0	51.5	41.5	21.0	17.7	10.0	12.0	150	5.30
3444	SKP-S 50-12		M12	13.0	10.1	13.0	51.5	41.5	21.0	19.0	10.0	12.0	150	5.40
3445	SKP-S 50-14		M14	15.0	10.1	13.0	56.5	44.5	21.0	20.5	12.0	15.0	150	5.70
3446	SKP-S 70-8	70 mm ²	M8	8.5	11.2	14.5	54.6	44.6	23.0	21.1	10.0	12.0	100	7.10
3447	SKP-S 70-10		M10	10.5	11.2	14.5	54.6	44.6	23.0	21.1	10.0	12.0	100	7.10
3448	SKP-S 70-12		M12	13.0	11.2	14.5	54.6	44.6	23.0	21.1	10.0	12.0	100	7.10
3449	SKP-S 70-14		M14	15.0	11.2	14.5	62.6	47.6	23.0	21.4	15.0	15.0	100	7.50
3450	SKP-S 95-8	95 mm ²	M8	8.5	13.4	17.0	58.8	48.8	26.0	24.5	10.0	12.0	75	7.70
3451	SKP-S 95-10		M10	10.5	13.4	17.0	58.8	48.8	26.0	24.5	10.0	12.0	75	7.70
3452	SKP-S 95-12		M12	13.0	13.4	17.0	58.8	48.8	26.0	24.5	10.0	12.0	75	7.60
3453	SKP-S 120-10	120 mm ²	M10	10.5	15.5	19.0	69.0	56.0	29.0	28.0	13.0	14.5	50	11.10
3454	SKP-S 120-12		M12	13.0	15.5	19.0	69.0	56.0	29.0	28.0	13.0	14.5	50	11.00
3455	SKP-S 120-16		M16	17.0	15.5	19.0	69.0	56.0	29.0	28.0	13.0	14.5	50	11.10
3456	SKP-S 150-10	150 mm ²	M10	10.5	16.5	21.0	76.5	60.0	30.0	30.0	16.5	16.5	40	17.00
3457	SKP-S 150-12		M12	13.0	16.5	21.0	76.5	60.0	30.0	30.0	16.5	16.5	40	16.80
3458	SKP-S 150-16		M16	17.0	16.5	21.0	76.5	60.0	30.0	30.0	16.5	16.5	40	17.00
3459	SKP-S 185-12	185 mm ²	M12	13.0	18.5	23.0	82.5	65.5	33.0	34.0	17.0	18.0	30	19.00
3460	SKP-S 185-16		M16	17.0	18.5	23.0	82.5	65.5	33.0	34.0	17.0	18.0	30	19.00
3461	SKP-S 240-12	240 mm ²	M12	13.0	21.0	26.0	89.0	72.0	38.0	38.0	17.0	18.0	25	26.00
3462	SKP-S 240-16		M16	17.0	21.0	26.0	89.0	72.0	38.0	38.0	17.0	18.0	25	26.00

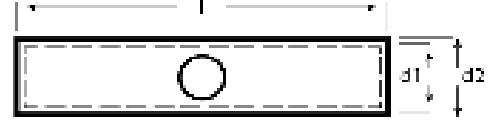

Malzeme : EN13600 Standart Bakır

Yüzey : Kalay

EK MUFLARI

Sipariş Kodu	Ürün Kodu	Kablo Kesit (mm ²)	Boyutlar			Kutu/Amb. Adet	Birim Fiyat TL / Adet
			d1	d2	l		
3465	EKMUF - 10	10	4.4	6.0	27.0	1.000	1.15
3466	EKMUF - 16	16	5.5	8.0	32.0	400	1.20
3467	EKMUF - 25	25	7.0	9.0	40.5	250	2.00
3468	EKMUF - 35	35	8.2	11.0	45.5	150	2.70
3469	EKMUF - 50	50	9.5	13.5	53.5	90	3.10
3470	EKMUF - 70	70	11.2	14.5	57.5	65	5.20
3471	EKMUF - 95	95	13.4	17.0	61.5	50	6.10
3472	EKMUF - 120	120	15.0	19.5	74.0	40	8.70
3473	EKMUF - 150	150	16.5	21.0	79.0	25	13.50
3474	EKMUF - 185	185	19.0	24.0	85.0	22	16.00
3475	EKMUF - 240	240	21.0	26.0	94.0	18	24.00

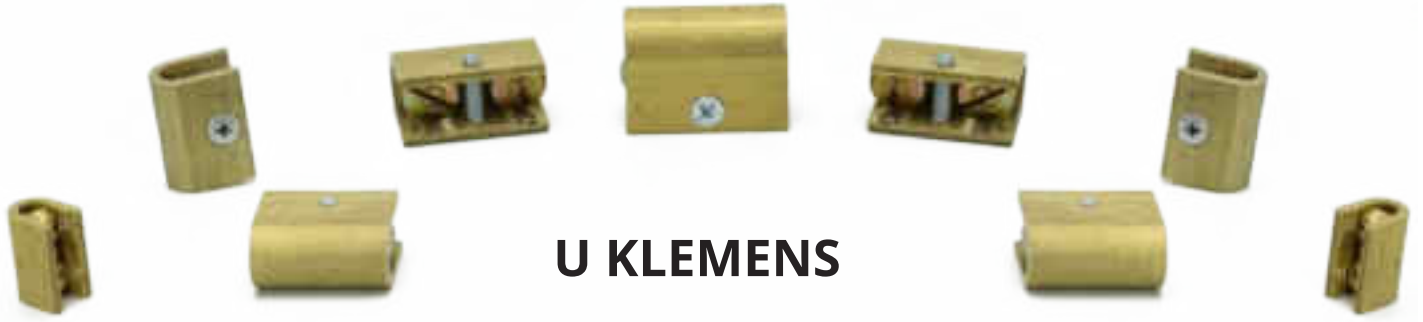

U KLEMENS

Sipariş Kodu	Ürün Kodu	Açıklama	Kutu Adet	Birim Fiyat TL / Adet
3480	U 6	6mm U Klemens	150	2.30
3481	U 10	10mm U Klemens	125	3.70
3482	U 16	16mm U Klemens	100	5.50
3483	U 25	25mm U Klemens	100	6.30
3484	U 35	35mm U Klemens	75	7.70
3485	U 50	50mm U Klemens	50	14.50
3486	U 70	70mm U Klemens	40	18.00
3487	U 95	95mm U Klemens	25	19.00
3488	U 120	120mm U Klemens	20	31.00
3489	U 150	150mm U Klemens	15	45.00



MONTAJ RAYLARI

**35x7,5**

Sipariş Kodu	Ürün Kodu	Açıklama	Uzunluk (m.)	Kutu Adet	Birim Fiyat TL / Adet
3495	GW - MR1	1mm Delikli Saç Montaj Rayı	1 m.	50	7.00
3496	GW - MR2	1mm Delikli Saç Montaj Rayı	2 m.	25	14.00

TRİFAZE BARALAR

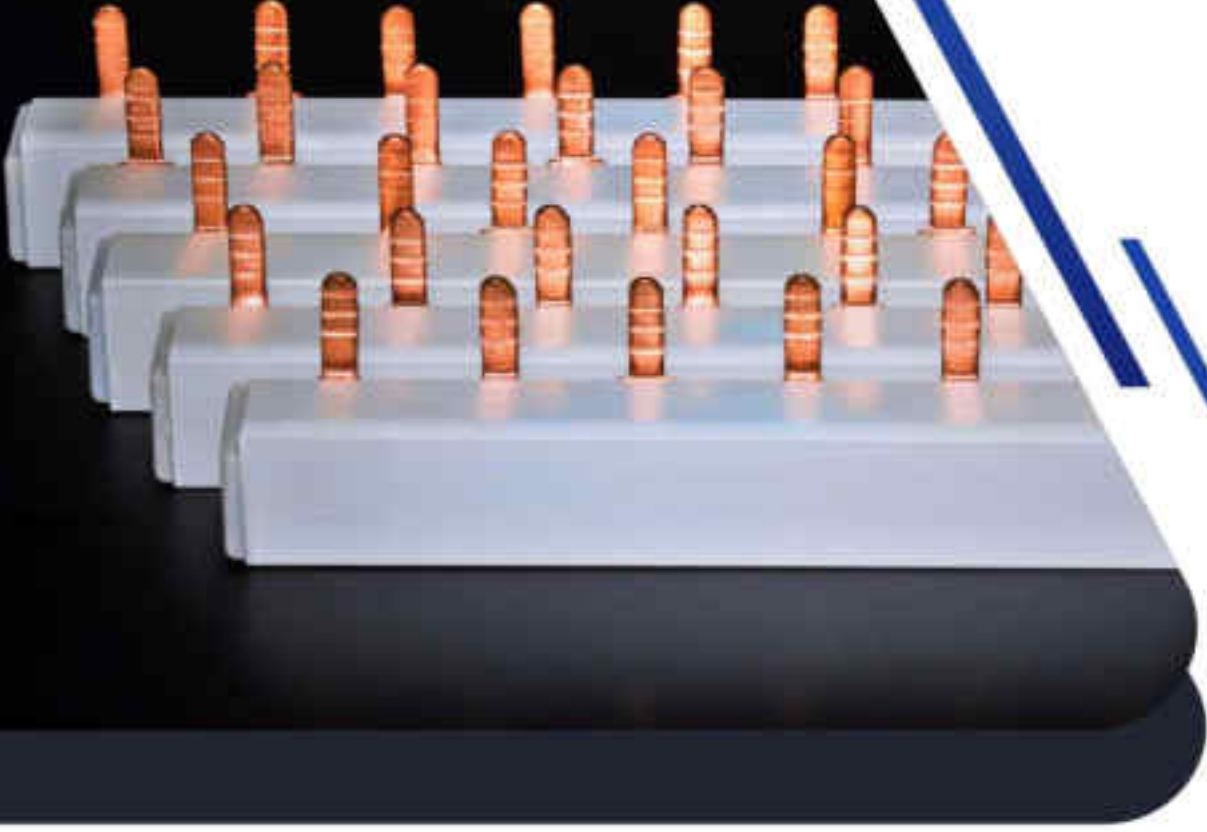

GWEST®

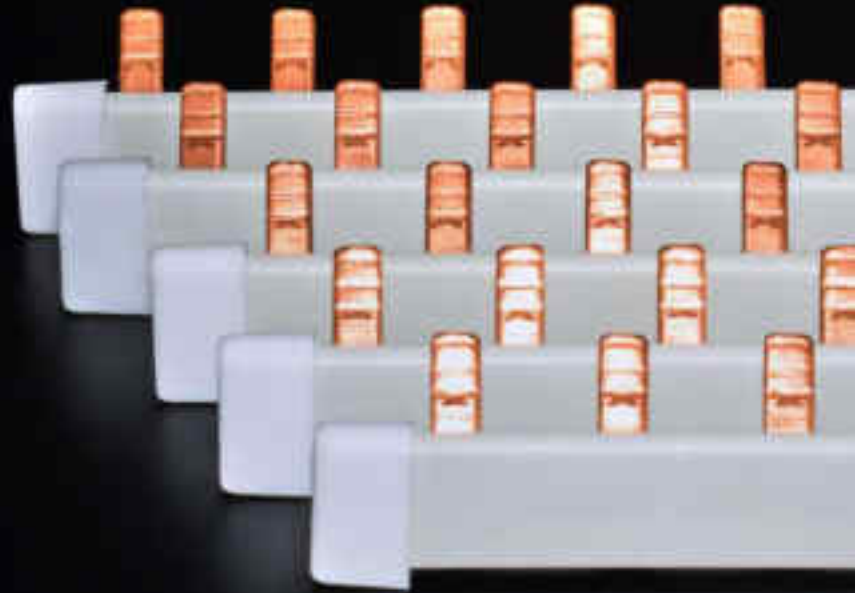

İMALATIMIZDIR.

MONOFAZE BARALAR

MONOFAZE MÜŞTEREK W OTOMAT BARALARI

Sipariş Kodu	Ürün Kodu	Bakır Kalınlığı	Boy	Modül	Amper	Açıklama	Kutu Adet	Fiyat TL / Adet
3601	M - 531	1 mm	53 cm	30 Otomat için	80 A	Monofaze Müşterek W Otomat Bara	50	15.00
3602	M - 1061	1 mm	106 cm	60 Otomat için	80 A	Monofaze Müşterek W Otomat Bara	50	30.00
3603	M - 5315	1.5 mm	53 cm	30 Otomat için	100 A	Monofaze Müşterek W Otomat Bara	50	23.00
3604	M - 10615	1.5 mm	106 cm	60 Otomat için	100 A	Monofaze Müşterek W Otomat Bara	50	46.00

TRİFAZE MÜŞTEREK W OTOMAT BARALARI

Sipariş Kodu	Ürün Kodu	Bakır Kalınlığı	Boy	Modül	Amper	Açıklama	Kutu Adet	Fiyat TL / Adet
3605	T - 221	1 mm	22 cm	4 Grup için	80 A	Trifaze Müşterek W Otomat Bara		16.00
3606	T - 331	1 mm	33 cm	6 Grup için	80 A	Trifaze Müşterek W Otomat Bara		24.00
3607	T - 441	1 mm	44 cm	8 Grup için	80 A	Trifaze Müşterek W Otomat Bara		32.00
3608	T - 531	1 mm	53 cm	10 Grup için	80 A	Trifaze Müşterek W Otomat Bara	25	40.00
3609	T - 1061	1 mm	106 cm	20 Grup için	80 A	Trifaze Müşterek W Otomat Bara	25	80.00

3610	T - 2215	1,5 mm	22 cm	4 Grup için	100 A	Trifaze Müşterek W Otomat Bara		24.00
3611	T - 3315	1,5 mm	33 cm	6 Grup için	100 A	Trifaze Müşterek W Otomat Bara		36.00
3612	T - 4415	1,5 mm	44 cm	8 Grup için	100 A	Trifaze Müşterek W Otomat Bara		48.00
3613	T - 5315	1,5 mm	53 cm	10 Grup için	100 A	Trifaze Müşterek W Otomat Bara	25	60.00
3614	T - 10615	1,5 mm	106 cm	20 Grup için	100 A	Trifaze Müşterek W Otomat Bara	25	120.00

3615	Gwest - KAP				Bara Kapağı		500	0.27
------	-------------	--	--	--	-------------	--	-----	------

İSTEDİĞİNİZ ÖLÇÜDE KESİM YAPILIR.

2 KUTUPLU DAĞITICI ÜNİTELER

Birim Fiyat TL / Adet	25.00	
SİPARİŞ KODU	3701	
ÜRÜN KODU	GW - 2x7	
AKIM	125 Amper	
KABLO CİNSİ	Tek Damar	Çok Telli
KABLO KESİTİ (mm²)	Giriş	Çıkış
	1x10-35 mm ²	1x10-25 mm ² 5x2,5-6 mm ²
	1x10-16 mm ²	1x6-16 mm ² 5x1,5-6 mm ²
Ambalaj Adet	Paket	Koli
	1	138



Birim Fiyat TL / Adet	35.00	
SİPARİŞ KODU	3702	
ÜRÜN KODU	GW - 2x11	
AKIM	125 Amper	
KABLO CİNSİ	Tek Damar	Çok Telli
KABLO KESİTİ (mm²)	Giriş	Çıkış
	2x10-35 mm ²	2x10-25 mm ² 7x2,5-6 mm ²
	2x10-16 mm ²	2x6-16 mm ² 7x1,5-6 mm ²
Ambalaj Adet	Paket	Koli
	1	84



Birim Fiyat TL / Adet	45.00	
SİPARİŞ KODU	3703	
ÜRÜN KODU	GW - 2x15	
AKIM	125 Amper	
KABLO CİNSİ	Tek Damar	Çok Telli
KABLO KESİTİ (mm²)	Giriş	Çıkış
	2x10-35 mm ²	2x10-25 mm ² 11x2,5-6 mm ²
	2x10-16 mm ²	2x6-16 mm ² 11x1,5-6 mm ²
Ambalaj Adet	Paket	Koli
	1	72



4 KUTUPLU DAĞITICI ÜNİTELER



Birim Fiyat TL / Adet	46.00	
SİPARİŞ KODU	3704	
ÜRÜN KODU	GW - 4x7	
AKIM	125 Amper	
KABLO CİNSİ	Tek Damar	Çok Telli
KABLO KESİTİ (mm²)	Giriş	Çıkış
	1x10-35 mm ²	1x10-25 mm ² 5x2,5-6 mm ²
	1x10-16 mm ²	1x6-16 mm ² 5x1,5-6 mm ²
Ambalaj Adet	Paket	Koli
	1	74



Birim Fiyat TL / Adet	65.00	
SİPARİŞ KODU	3705	
ÜRÜN KODU	GW - 4x11	
AKIM	125 Amper	
KABLO CİNSİ	Tek Damar	Çok Telli
KABLO KESİTİ (mm²)	Giriş	Çıkış
	2x10-35 mm ²	2x10-25 mm ² 7x2,5-6 mm ²
	2x10-16 mm ²	2x6-16 mm ² 7x1,5-6 mm ²
Ambalaj Adet	Paket	Koli
	1	50



Birim Fiyat TL / Adet	82.00	
SİPARİŞ KODU	3706	
ÜRÜN KODU	GW - 4x15	
AKIM	125 Amper	
KABLO CİNSİ	Tek Damar	Çok Telli
KABLO KESİTİ (mm²)	Giriş	Çıkış
	2x10-35 mm ²	2x10-25 mm ² 11x2,5-6 mm ²
	2x10-16 mm ²	2x6-16 mm ² 11x1,5-6 mm ²
Ambalaj Adet	Paket	Koli
	1	40



Birim Fiyat TL / Adet	200.00	
SİPARİŞ KODU	3707	
ÜRÜN KODU	GW - 4x12/160A	
AKIM	160 Amper	
KABLO CİNSİ	Tek Damar	Çok Telli
KABLO KESİTİ (mm²)	Giriş	Çıkış
	1x10-50 mm ²	3x10-35 mm ² 8x2,5-16 mm ²
	1x10-50 mm ²	3x6-25 mm ² 8x1,5-16 mm ²
Ambalaj Adet	Paket	Koli
	1	18

TEK KUTUPLU DAĞITICI ÜNİTELER

Birim Fiyat TL / Adet	21.00	
SİPARİŞ KODU	3708	
ÜRÜN KODU	GW - 80A	
AKIM	80 Amper	
KABLO KESİTİ (mm²)	Giriş	Çıkış
	1x10-16 mm ²	4x2,5-6 mm ² 2x2,5-16 mm ²
Ambalaj Adet	Paket	Koli
	5	100



Birim Fiyat TL / Adet	44.00	
SİPARİŞ KODU	3709	
ÜRÜN KODU	GW - 125A	
AKIM	125 Amper	
KABLO KESİTİ (mm²)	Giriş	Çıkış
	1x10-35 mm ²	6x2,5-16 mm ² Köprü 1x6-16 mm ²
Ambalaj Adet	Paket	Koli
	5	75



Birim Fiyat TL / Adet	46.00	
SİPARİŞ KODU	3710	
ÜRÜN KODU	GW - 160A	
AKIM	160 Amper	
KABLO KESİTİ (mm²)	Giriş	Çıkış
	1x10-70 mm ²	6x2,5-16 mm ² Köprü 1x6-16 mm ²
Ambalaj Adet	Paket	Koli
	5	50



TEK KUTUPLU DAĞITICI ÜNİTELER

Birim Fiyat TL / Adet	128.00	
SİPARİŞ KODU	3711	
ÜRÜN KODU	GW - 250A	
AKIM	250 Amper	
KABLO KESİTİ (mm ²)	Giriş	Çıkış
	1x35-120 mm ²	4x2,5-10 mm ² 5x2,5-16 mm ² 2x6-35 mm ²
Ambalaj Adet	Paket	Koli
	3	30



Birim Fiyat TL / Adet	135.00	
SİPARİŞ KODU	3712	
ÜRÜN KODU	GW - 400A	
AKIM	400 Amper	
KABLO KESİTİ (mm ²)	Giriş	Çıkış
	1x95-185 mm ²	4x2,5-10 mm ² 5x2,5-16 mm ² 2x6-35 mm ²
Ambalaj Adet	Paket	Koli
	3	20



Birim Fiyat TL / Adet	145.00	
SİPARİŞ KODU	3713	
ÜRÜN KODU	GW - 500A	
AKIM	500 Amper	
KABLO KESİTİ (mm ²)	Giriş	Çıkış
	8x24 mm ²	4x2,5-10 mm ² 5x2,5-16 mm ² 2x6-35 mm ²
Ambalaj Adet	Paket	Koli
	3	20





NÖTR VİDALI TOPRAKLAMA BARALARI

	Sipariş Kodu	Ürün Kodu	Modül	Bakır Kalınlığı	Kutu Adet	Birim Fiyat TL / Adet
	3635	G / B - 1.5 / 31	31 Vida	1.5 x 15.0	20	54.00
	3636	G / B - 1.5 / 61	61 Vida	1.5 x 15.0	20	57.00
	3637	G / B - 2.0 / 31	31 Vida	2.0 x 15.0	20	70.00
	3638	G / B - 2.0 / 61	61 Vida	2.0 x 15.0	20	75.00
	3639	G / B - 3.0 / 31	31 Vida	3.0 x 15.0	20	103.00
	3640	G / B - 3.0 / 61	61 Vida	3.0 x 15.0	20	110.00

BARA MESNEDİ

	Sipariş Kodu	Ürün Kodu	Açıklama	Kutu Adet	Birim Fiyat TL / Adet
	3801	GVN - BM	Topraklama Barası Bara Mesnedi	500	3.20

80 A. MODÜLER NÖTR KLEMENSLERİ

	Sipariş Kodu	Ürün Kodu	Açıklama	Kutu Adet	Birim Fiyat TL / Adet
	3802	GVN - MNK - 011	Modüler Nötr Klemensi İç Bara	300	6.90
	3803	GVN - MNK - 130	Modüler Nötr Klemensi 1x30	40	33.00
	3804	GVN - MNK - 211	Modüler Nötr Klemensi 2x11	40	22.00
	3805	GVN - MNK - 311	Modüler Nötr Klemensi 3x11	40	27.00
	3806	GVN - MNK - 230	Modüler Nötr Klemensi 2x8+2x8	40	
	3807	GVN - MNK - 240	Modüler Nötr Klemensi 2x8+2x12	40	

125 A. KUTUPLU DAĞITIM ÜNİTESİ (7x12mm)

	Sipariş Kodu	Ürün Kodu	Açıklama	Kutu Adet	Birim Fiyat TL / Adet
	3808	GVN - DU - 125107	2+5 DELİKLİ	50	12.50
	3809	GVN - DU - 125110	2+6 DELİKLİ	40	15.00
	3810	GVN - DU - 125112	2+10 DELİKLİ	30	17.00
	3811	GVN - DU - 125115	2+13 DELİKLİ	30	20.00
	3812	GVN - DU - 125120	2+18 DELİKLİ	20	25.00
	3813	GVN - DU - 125122	2+20 DELİKLİ	20	26.00
	3814	GVN - DU - 125125	2+23 DELİKLİ	20	29.00

160 A. KUTUPLU DAĞITIM ÜNİTESİ (10x15mm)

	Sipariş Kodu	Ürün Kodu	Açıklama	Kutu Adet	Birim Fiyat TL / Adet
	3815	GVN - DU - 160107	2+5 DELİKLİ	25	31.00
	3816	GVN - DU - 160108	2+6 DELİKLİ	25	36.00
	3817	GVN - DU - 160112	2+10 DELİKLİ	15	42.00
	3818	GVN - DU - 160115	2+13 DELİKLİ	15	46.50
	3819	GVN - DU - 160220	2+18 DELİKLİ	10	49.00
	3820	GVN - DU - 160122	2+20 DELİKLİ	10	79.00

63 A. PANO TOPRAKLAMA KLEMENSLERİ (6x8mm)

	Sipariş Kodu	Ürün Kodu	Açıklama	Kutu Adet	Birim Fiyat TL / Adet
	3821	GVN - TK - 06304	4 DELİKLİ	1.000	2.60
	3822	GVN - TK - 06305	5 DELİKLİ	750	3.20
	3823	GVN - TK - 06306	6 DELİKLİ	500	3.50
	3824	GVN - TK - 06307	7 DELİKLİ	500	4.00
	3825	GVN - TK - 06309	9 DELİKLİ	500	5.00
	3826	GVN - TK - 06310	10 DELİKLİ	500	5.50
	3827	GVN - TK - 06312	12 DELİKLİ	500	6.30
	3828	GVN - TK - 06315	15 DELİKLİ	250	7.70
	3829	GVN - TK - 06322	22 DELİKLİ	200	11.50

80 A. PANO TOPRAKLAMA KLEMENSLERİ (6.5x9mm)

	Sipariş Kodu	Ürün Kodu	Açıklama	Kutu Adet	Birim Fiyat TL / Adet
	3830	GVN - TK - 08004	4 DELİKLİ	1.000	3.30
	3831	GVN - TK - 08005	5 DELİKLİ	750	3.80
	3832	GVN - TK - 08006	6 DELİKLİ	500	4.40
	3833	GVN - TK - 08007	7 DELİKLİ	500	5.00
	3834	GVN - TK - 08009	9 DELİKLİ	500	6.00
	3835	GVN - TK - 08010	10 DELİKLİ	500	6.80
	3836	GVN - TK - 08012	12 DELİKLİ	500	7.50
	3837	GVN - TK - 08015	15 DELİKLİ	250	9.50
	3838	GVN - TK - 08022	22 DELİKLİ	200	13.70
	3839	GVN - TK - 08032	32 DELİKLİ	125	19.50
	3840	GVN - TK - 08042	42 DELİKLİ	125	25.80
	3841	GVN - TK - 08062	62 DELİKLİ	50	36.80
	3842	GVN - TK - 08082	82 DELİKLİ	50	48.00

125 A. PANO TOPRAKLAMA KLEMENSLERİ (7x12mm)

	Sipariş Kodu	Ürün Kodu	Açıklama	Kutu Adet	Birim Fiyat TL / Adet
	3843	GVN - TK - 12505	5 DELİKLİ	250	6.30
	3844	GVN - TK - 12506	6 DELİKLİ	250	7.30
	3845	GVN - TK - 12507	7 DELİKLİ	250	8.20
	3846	GVN - TK - 12509	9 DELİKLİ	250	9.30
	3847	GVN - TK - 12510	10 DELİKLİ	250	10.00
	3848	GVN - TK - 12512	12 DELİKLİ	250	13.00
	3849	GVN - TK - 12515	15 DELİKLİ	150	16.00
	3850	GVN - TK - 12522	22 DELİKLİ	100	23.00
	3851	GVN - TK - 12532	32 DELİKLİ	100	34.00
	3852	GVN - TK - 12542	42 DELİKLİ	50	44.00
	3853	GVN - TK - 12562	62 DELİKLİ	50	62.00
	3854	GVN - TK - 12582	82 DELİKLİ	50	82.00

1 METRE PANO TOPRAKLAMA KLEMENSLER

	Sipariş Kodu	Ürün Kodu	Açıklama	Kutu Adet	Birim Fiyat TL / Adet
	3855	GVN - TK - 080100	1 METRE 80.A	30	103.00
	3856	GVN - TK - 125100	1 METRE 125 A.	20	145.00

80 A. AYAKLI PANO NÖTR KLEMENSLERİ (6.5x9mm)

	Sipariş Kodu	Ürün Kodu	Açıklama	Kutu Adet	Birim Fiyat TL / Adet
		3857	GVN - NK - 08006	6 DELİKLİ	125
	3858	GVN - NK - 08007	7 DELİKLİ	125	7.00
	3859	GVN - NK - 08009	9 DELİKLİ	100	8.00
	3860	GVN - NK - 08010	10 DELİKLİ	100	8.80
	3861	GVN - NK - 08012	12 DELİKLİ	100	10.00
	3862	GVN - NK - 08015	15 DELİKLİ	75	11.00
	3863	GVN - NK - 08020	20 DELİKLİ	50	14.00
	3864	GVN - NK - 08022	22 DELİKLİ	50	16.00
	3865	GVN - NK - 08025	25 DELİKLİ	50	17.00
	3866	GVN - NK - 08030	30 DELİKLİ	50	20.00
	3867	GVN - NK - 08032	32 DELİKLİ	50	21.50
	3868	GVN - NK - 08042	42 DELİKLİ	40	28.50
	3869	GVN - NK - 08062	62 DELİKLİ	30	40.50
	3870	GVN - NK - 08082	82 DELİKLİ	15	52.00

125 A. AYAKLI PANO NÖTR KLEMENSLERİ (7x12mm)

	Sipariş Kodu	Ürün Kodu	Açıklama	Kutu Adet	Birim Fiyat TL / Adet
		3871	GVN - NK - 12506	6 DELİKLİ	125
	3872	GVN - NK - 12507	7 DELİKLİ	125	10.00
	3873	GVN - NK - 12509	9 DELİKLİ	100	12.00
	3874	GVN - NK - 12510	10 DELİKLİ	100	12.50
	3875	GVN - NK - 12512	12 DELİKLİ	100	14.50
	3876	GVN - NK - 12515	15 DELİKLİ	75	17.50
	3877	GVN - NK - 12520	20 DELİKLİ	50	22.00
	3878	GVN - NK - 12522	22 DELİKLİ	50	24.00
	3879	GVN - NK - 12525	25 DELİKLİ	50	26.00
	3880	GVN - NK - 12530	30 DELİKLİ	50	31.00
	3881	GVN - NK - 12532	32 DELİKLİ	50	34.00
	3882	GVN - NK - 12542	42 DELİKLİ	40	43.00
	3883	GVN - NK - 12562	62 DELİKLİ	30	62.50
	3884	GVN - NK - 12582	82 DELİKLİ	15	82.50

160 A. AYAKLI PANO NÖTR KLEMENSLERİ (10x15mm)

	Sipariş Kodu	Ürün Kodu	Açıklama	Kutu Adet	Birim Fiyat TL / Adet
		3885	GVN - NK - 16007	7 DELİKLİ	50
	3886	GVN - NK - 16009	9 DELİKLİ	30	26.00
	3887	GVN - NK - 16010	10 DELİKLİ	30	30.00
	3888	GVN - NK - 16012	12 DELİKLİ	25	34.00
	3889	GVN - NK - 16015	15 DELİKLİ	25	40.00
	3890	GVN - NK - 16022	22 DELİKLİ	25	55.00
	3891	GVN - NK - 16032	32 DELİKLİ	25	76.00
	3892	GVN - NK - 16042	42 DELİKLİ	25	98.00

80 A. AYAKSIZ PANO NÖTR KLEMENSLERİ (6.5x9mm)

	Sipariş Kodu	Ürün Kodu	Açıklama	Kutu Adet	Birim Fiyat TL / Adet
	3893	GVN - ATK - 08006	6 DELİKLİ	500	6.00
	3894	GVN - ATK - 08007	7 DELİKLİ	350	6.50
	3895	GVN - ATK - 08009	9 DELİKLİ	350	7.50
	3896	GVN - ATK - 08010	10 DELİKLİ	350	8.00
	3897	GVN - ATK - 08012	12 DELİKLİ	250	9.00
	3898	GVN - ATK - 08015	15 DELİKLİ	200	10.80
	3899	GVN - ATK - 08020	20 DELİKLİ	200	13.80
	3900	GVN - ATK - 08022	22 DELİKLİ	200	15.50
	3901	GVN - ATK - 08025	25 DELİKLİ	150	16.50
	3902	GVN - ATK - 08030	30 DELİKLİ	125	19.00
	3903	GVN - ATK - 08032	32 DELİKLİ	125	21.00
	3904	GVN - ATK - 08042	42 DELİKLİ	100	28.00
3905	GVN - ATK - 08062	62 DELİKLİ	50	40.00	
3906	GVN - ATK - 08082	82 DELİKLİ	50	51.50	

125 A. AYAKSIZ PANO NÖTR KLEMENSLERİ (7x12mm)

	Sipariş Kodu	Ürün Kodu	Açıklama	Kutu Adet	Birim Fiyat TL / Adet
	3907	GVN - ATK - 12506	6 DELİKLİ	125	8.80
	3908	GVN - ATK - 12507	7 DELİKLİ	125	9.50
	3909	GVN - ATK - 12509	9 DELİKLİ	100	11.00
	3910	GVN - ATK - 12510	10 DELİKLİ	100	12.00
	3911	GVN - ATK - 12512	12 DELİKLİ	100	14.30
	3912	GVN - ATK - 12515	15 DELİKLİ	75	16.50
	3913	GVN - ATK - 12520	20 DELİKLİ	50	21.00
	3914	GVN - ATK - 12522	22 DELİKLİ	50	23.00
	3915	GVN - ATK - 12525	25 DELİKLİ	50	25.00
	3916	GVN - ATK - 12530	30 DELİKLİ	50	30.00
	3917	GVN - ATK - 12532	32 DELİKLİ	50	33.00
	3918	GVN - ATK - 12542	42 DELİKLİ	40	42.00
3919	GVN - ATK - 12562	62 DELİKLİ	30	62.00	
3920	GVN - ATK - 12582	82 DELİKLİ	15	81.00	

160 A. AYAKSIZ PANO NÖTR KLEMENSLERİ (10x15mm)

	Sipariş Kodu	Ürün Kodu	Açıklama	Kutu Adet	Birim Fiyat TL / Adet
	3921	GVN - ATK - 16007	7 DELİKLİ	100	23.00
	3922	GVN - ATK - 16009	9 DELİKLİ	100	26.50
	3923	GVN - ATK - 16010	10 DELİKLİ	75	30.00
	3924	GVN - ATK - 16012	12 DELİKLİ	50	33.00
	3925	GVN - ATK - 16015	15 DELİKLİ	25	40.00
	3926	GVN - ATK - 16022	22 DELİKLİ	25	55.00
	3927	GVN - ATK - 16032	32 DELİKLİ	25	76.00
	3928	GVN - ATK - 16042	42 DELİKLİ	25	98.00





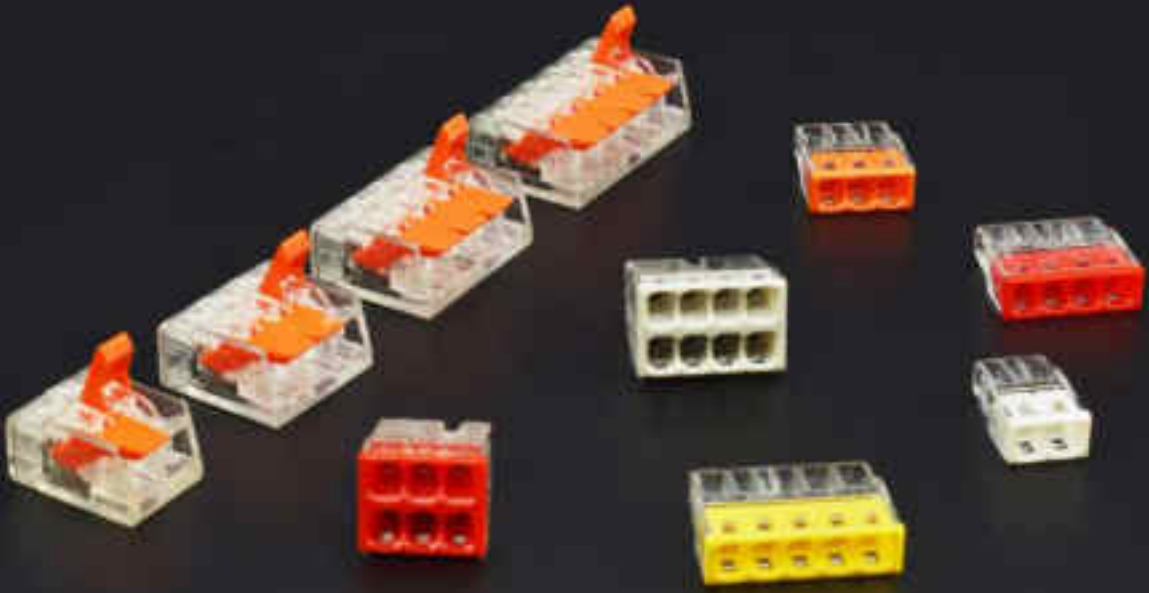

PLASTİK NÖTR AYIĞI

	Sipariş Kodu	Ürün Kodu	Açıklama	Kutu Adet	Birim Fiyat TL / Adet
	3929	GVN - PA - 080	80 A. AYAK	500	1.50
	3930	GVN - PA - 125	125 A. AYAK	500	1.50
3931	GVN - PA - 160	160 A. AYAK	500	1.50	







KOMPAKT ÇOK AMAÇLI KLEMENSLER

GEÇMELİ BUAT KLEMENS

	Sipariş Kodu	Ürün Kodu	Renk	Kablo Kesiti	Ebatlar			Ambalaj Adet		Birim Fiyat TL / Adet
					En	Boy	Yükseklik	Paket	Koli	
	3501	GW 2,5 - 2	Beyaz	0,50 - 2,5 mm ²	9.8	16.4	5.8	200	10.000	0.58
	3502	GW 2,5 - 3	Turuncu	0,50 - 2,5 mm ²	13.9	16.4	5.8	200	10.000	0.65
	3503	GW 2,5 - 4	Kırmızı	0,50 - 2,5 mm ²	17.9	16.4	5.8	100	5.000	0.80
	3504	GW 2,5 - 5	Sarı	0,50 - 2,5 mm ²	21.9	16.4	5.8	100	5.000	0.85
	3505	GW 2,5 - 6	Kırmızı	0,50 - 2,5 mm ²	13.8	16.4	11.25	100	5.000	1.20
	3506	GW 2,5 - 8	Gri	0,50 - 2,5 mm ²	17.8	16.4	11.25	100	5.000	1.70

ÇOK AMAÇLI KLEMENS

	Sipariş Kodu	Ürün Kodu	Kablo Kesiti	Açıklama	Ambalaj Adet		Birim Fiyat TL / Adet
					Paket	Koli	
	3507	GW - 412	0,14 - 4,0 mm ²	2 İletken Bağlantılı	100	5.000	1.20
	3508	GW - 413	0,14 - 4,0 mm ²	3 İletken Bağlantılı	100	5.000	1.60
	3509	GW - 414	0,14 - 4,0 mm ²	4 İletken Bağlantılı	50	2.500	2.20
	3510	GW - 415	0,14 - 4,0 mm ²	5 İletken Bağlantılı	50	2.500	2.50

Çalışma Sıcaklığı: -40°C + 105°C

Nominal Akım : 32A

Nominal Gerilim : 450V



GÜVEN
ELEKTRİK ELEKTRONİK LTD. ŞTİ.

MAKARON GRUBU ve BANT ÇEŞİTLERİ



www.guvenelektrik.com.tr



ISI İLE DARALAN SİYAH MAKARONLAR

TEKNİK ÖZELLİKLER



Malzeme : Polyolefin

Daralma Oranı : 2/1

Yanmazlık : Kendi kendine söner

Çalışma Sıcaklığı : -55°C -- +125°C

Sipariş Kodu	Ölçü		Daralmadan Önce (mm)		Daralmadan Sonra (mm)		Makara / Mt.	Koli Miktarı	Birim Fiyat USD / Mt.
	Inch	mm	İç Çap	Cidar Kalınlığı	İç Çap	Cidar Kalınlığı			
4015	—	1	2,0 ± 0,3	0,16 ± 0,05	0,70	0,30 ± 0,05	200	3.200	0.061
4016	—	1,5	2,0 ± 0,3	0,16 ± 0,05	0,80	0,30 ± 0,05	200	2.400	0.063
4017	—	2	2,5 ± 0,3	0,16 ± 0,05	1,00	0,35 ± 0,05	200	3.000	0.069
4003	3/32	2,4	3,0 ± 0,3	0,16 ± 0,05	1,50	0,35 ± 0,05	200	3.000	0.069
4018	—	2,5	3,0 ± 0,3	0,16 ± 0,05	1,25	0,38 ± 0,05	200	2.600	0.088
4019	—	3	3,5 ± 0,4	0,20 ± 0,05	1,50	0,38 ± 0,05	200	2.200	0.095
4004	1/8	3,2	3,5 ± 0,4	0,20 ± 0,05	1,75	0,40 ± 0,05	200	2.200	0.095
4020	—	3,5	4,0 ± 0,4	0,20 ± 0,05	1,75	0,40 ± 0,05	200	1.800	0.10
4021	—	4	4,5 ± 0,4	0,20 ± 0,05	2,00	0,45 ± 0,05	200	1.400	0.12
4022	—	4,5	4,8 ± 0,4	0,20 ± 0,05	2,00	0,47 ± 0,08	100	1.000	0.14
4005	3/16	4,8	5,2 ± 0,4	0,20 ± 0,05	2,60	0,47 ± 0,08	100	1.000	0.14
4023	—	5	5,5 ± 0,4	0,20 ± 0,05	2,50	0,55 ± 0,08	100	900	0.15
4024	—	6	6,5 ± 0,4	0,22 ± 0,05	3,00	0,55 ± 0,08	100	700	0.17
4006	1/4	6,4	7,0 ± 0,4	0,28 ± 0,05	3,50	0,55 ± 0,08	100	700	0.17
4025	—	7	7,5 ± 0,4	0,28 ± 0,05	3,50	0,60 ± 0,08	100	500	0.21
4026	—	8	8,5 ± 0,4	0,30 ± 0,08	4,00	0,60 ± 0,08	100	1.300	0.21
4007	3/8	9,5	10,0 ± 0,5	0,30 ± 0,08	5,00	0,60 ± 0,08	100	1.200	0.22
4028	—	10	10,0 ± 0,5	0,30 ± 0,08	5,00	0,60 ± 0,08	100	1.100	0.24
4008	1/2	12,7	13,0 ± 0,5	0,33 ± 0,10	6,50	0,65 ± 0,08	100	1.000	0.27
4031	—	13	13,5 ± 0,5	0,33 ± 0,10	6,50	0,65 ± 0,08	100	900	0.29
4032	—	14	14,5 ± 0,5	0,33 ± 0,10	7,00	0,70 ± 0,08	100	900	0.35
4034	4/5	16	16,5 ± 0,6	0,35 ± 0,12	8,00	0,75 ± 0,08	100	800	0.46
4036	—	18	19,0 ± 0,6	0,40 ± 0,15	9,00	0,80 ± 0,15	100	700	0.62
4009	3/4	19,1	20,5 ± 0,6	0,40 ± 0,15	10,00	0,80 ± 0,15	100	700	0.62
4038	—	20	20,5 ± 0,6	0,40 ± 0,15	10,00	0,80 ± 0,15	100	600	0.75
4039	—	22	22,5 ± 0,7	0,45 ± 0,15	12,00	0,95 ± 0,15	100	600	0.90
4010	1	25,4	25,6 ± 0,7	0,45 ± 0,15	12,00	0,95 ± 0,15	50	300	1.00
4040	—	30	31,5 ± 0,7	0,50 ± 0,15	15,00	0,95 ± 0,15	50	250	1.30
4011	1 - 1/4	32	33,0 ± 0,7	0,50 ± 0,15	16,50	0,95 ± 0,15	50	250	1.30
4041	—	35	38,0 ± 0,7	0,50 ± 0,15	16,00	1,00 ± 0,15	50	200	1.80
4012	1 - 1/2	38	40,0 ± 0,7	0,50 ± 0,15	20,00	1,00 ± 0,15	50	200	1.95
4042	—	40	40,5 ± 0,7	0,50 ± 0,15	20,00	1,00 ± 0,15	50	200	1.95
4013	2	51	52,5 ± 0,7	0,50 ± 0,15	25,00	1,00 ± 0,15	25	125	2.75
4043	—	60	60,5 ± 0,8	0,52 ± 0,15	30,00	1,00 ± 0,16	25	100	3.80
4044	—	70	70,5 ± 1,0	0,55 ± 0,15	40,00	1,10 ± 0,18	25	75	4.90
4045	—	80	82,0 ± 1,0	0,55 ± 0,15	40,00	1,10 ± 0,18	25	75	5.70
4050	—	90	90,0 ± 1,0	0,55 ± 0,15	45,00	1,10 ± 0,18	25	50	6.00
4046	4	102	105,0 ± 1,0	0,55 ± 0,15	51,00	1,10 ± 0,18	25	50	7.00
4047	—	120	120,0 ± 1,0	0,55 ± 0,15	60,00	1,10 ± 0,18	25	50	10.00
4048	—	150	150,0 ± 1,0	0,55 ± 0,15	76,00	1,10 ± 0,18	25	50	16.00
4049	—	180	180,0 ± 1,0	0,55 ± 0,15	90,00	1,10 ± 0,18	25	25	21.00

ISI İLE DARALAN RENKLİ MAKARONLAR

ŞEFFAF - BEYAZ - KIRMIZI - MAVİ - SARI - YEŞİL - GRİ

Ölçü		Sipariş Kodu							Makara / Mt.	Koli Miktarı	Fiyat Usd / Mt.
Inch	mm	ŞEFFAF	BEYAZ	KIRMIZI	MAVİ	SARI	YEŞİL	GRİ			
—	1,5	4201	4289	4219	4237	4254	4272	4306	200	3.200	0.08
—	2,5	4202	4290	4220	4238	4256	4273	4307	200	2.600	0.12
1/8	3,2	4203	4291	4221	4239	4257	4274	4308	200	2.200	0.14
—	3,5	—	4292	—	—	4258	—	—	200	1.800	0.14
Yassı	3,5	—	4395	—	—	4390	—	—	100	1.600	0.15
3/16	4,8	4204	4293	4222	4240	4259	4275	4309	100	1.000	0.16
Yassı	4,8	—	4396	—	—	4391	—	—	100	1.500	0.17
1/4	6,4	4205	4294	4224	4241	4260	4276	4310	100	700	0.21
Yassı	6,4	—	4397	—	—	4392	—	—	100	1.500	0.22
Yassı	7	—	4398	—	—	4393	—	—	100	1.400	0.24
3/8	9,5	4207	4295	4226	4242	4261	4278	4311	100	1.200	0.26
—	13	4208	4296	4227	4243	4262	4279	4312	100	900	0.35
4/5	16	4209	4297	4228	4244	4263	4280	4313	100	800	0.62
—	20	4210	4298	4229	4245	4264	4281	4314	100	600	1.10
1	25,4	4211	4299	4230	4246	4265	4282	4315	50	300	1.35
1 - 1/4	32	4212	4300	4231	4247	4266	4283	4316	50	250	1.82
1 - 1/2	38	4213	4301	4232	4248	4267	4284	4317	50	200	2.85
2	51	4214	4302	4233	4249	4268	4285	4318	25	125	3.15
—	60	4215	4303	4234	4250	4269	4286	4319	25	100	4.90
—	80	4216	4304	4235	4251	4270	4287	4320	25	75	6.10
4	102	4217	4305	4236	4252	4271	4288	4321	25	50	8.20



TEKNİK ÖZELLİKLER

- **Malzeme** : Polyolefin
- **Daralma Oranı** : 2/1
- **Yanmazlık** : Kendi kendine söner
- **Çalışma Sıcaklığı** : -55°C -- +125°C



ISI İLE DARALAN RENKLİ MAKARONLAR

KAHVERENGİ - TURUNCU - MOR

Ölçü		Sipariş Kodu			Makara / Mt.	Koli Miktarı	Fiyat Usd / Mt.
Inch	mm	KAHVERENGİ	TURUNCU	MOR			
—	1,5	4322	4338	4354	200	3.200	0.09
—	2,5	4323	4339	4355	200	2.600	0.13
1/8	3,2	4324	4340	4356	200	2.200	0.16
3/16	4,8	4325	4341	4357	100	1.000	0.21
1/4	6,4	4326	4342	4358	100	700	0.28
3/8	9,5	4327	4343	4359	100	1.200	0.32
—	13	4328	4344	4360	100	900	0.43
4/5	16	4329	4345	4361	100	800	0.85
—	20	4330	4346	4362	100	600	1.10
1	25,4	4331	4347	4363	50	300	1.50
1 - 1/4	32	4332	4348	4364	50	250	2.00
1 - 1/2	38	4333	4349	4365	50	200	3.20
2	51	4334	4350	4366	25	125	3.60
—	60	4335	4351	4367	25	100	5.50
—	80	4336	4352	4368	25	75	7.50
4	102	4337	4353	4369	25	50	10.00



TEKNİK ÖZELLİKLER

- **Malzeme :** Polyolefin
- **Daralma Oranı :** 2/1
- **Yanmazlık :** Kendi kendine söner
- **Çalışma Sıcaklığı :** -55°C -- +125°C



ISI İLE DARALAN MAKARONLAR

SARI YEŞİL

Sipariş Kodu	Ölçü		Daralmadan Önce (mm)		Daralmadan Sonra (mm)		Makara / Mt.	Koli Miktarı	Birim Fiyat USD / Mt.
	Inch	mm	İç Çap	Cidar Kalınlığı	İç Çap	Cidar Kalınlığı			
4102	3/32	2,4	3,0 ± 0,3	0,16 ± 0,05	1,50	0,35 ± 0,05	200	3.000	0.29
4103	1/8	3,2	3,5 ± 0,4	0,20 ± 0,05	1,75	0,40 ± 0,05	200	2.200	0.30
4104	3/16	4,8	5,2 ± 0,4	0,20 ± 0,05	2,60	0,47 ± 0,08	100	1.000	0.32
4105	1/4	6,4	7,0 ± 0,4	0,28 ± 0,05	3,50	0,55 ± 0,08	100	700	0.38
4106	3/8	9,5	10,0 ± 0,5	0,30 ± 0,08	5,00	0,60 ± 0,08	100	1.200	0.52
4107	—	13	13,5 ± 0,5	0,33 ± 0,10	6,50	0,65 ± 0,08	100	900	0.66
4108	4/5	16	16,5 ± 0,6	0,35 ± 0,12	8,00	0,75 ± 0,08	100	800	0.95
4109	—	20	20,5 ± 0,6	0,40 ± 0,15	10,00	0,80 ± 0,15	100	600	1.30
4110	1	25,4	25,6 ± 0,7	0,45 ± 0,15	12,00	0,95 ± 0,15	50	300	1.90
4111	1 - 1/4	32	33,0 ± 0,7	0,50 ± 0,15	16,50	0,95 ± 0,15	50	250	2.50
4112	1 - 1/2	38	40,0 ± 0,7	0,50 ± 0,15	20,00	1,00 ± 0,15	50	200	3.45
4113	2	51	52,5 ± 0,7	0,50 ± 0,15	25,00	1,00 ± 0,15	50	125	5.10
4114	—	60	60,5 ± 0,8	0,52 ± 0,15	30,00	1,00 ± 0,16	25	100	7.00
4115	—	80	82,0 ± 1,0	0,55 ± 0,15	40,00	1,10 ± 0,18	25	75	11.00
4116	4	102	105,0 ± 1,0	0,55 ± 0,15	51,00	1,10 ± 0,18	25	50	16.50



TEKNİK ÖZELLİKLER

- **Malzeme** : Polyolefin
- **Daralma Oranı** : 2/1
- **Yanmazlık** : Kendi kendine söner
- **Çalışma Sıcaklığı** : -55°C -- +125°C



İÇİ YAPIŞKANLI DARALAN MAKARONLAR

Sipariş Kodu	Ölçü mm	Daralmadan Önce (mm)	Daralmadan Sonra (mm)			Makara / Mt.	Koli Miktarı	Birim Fiyat USD / Mt.
		İç Çap	Azami İç Çap	Anma Cidar Kalınlığı	Anma Yapışkanlığı			
4418	3/1	3	1.00	1.10 ± 0.10	0.50	200	1.800	0.60
4419	4.8/1.5	4.8	1.50	1.20 ± 0.10	0.50	100	900	0.75
4420	6/2	6	2.00	1.30 ± 0.10	0.50	100	600	0.95
4421	9/3	9	3.00	1.70 ± 0.15	0.60	50	300	1.30
4405	12/4	12	4.00	2.00 ± 0.20	0.80	1.20 Boy	250	2.20
4406	16/5	16	5.00	2.20 ± 0.20	0.80	1.20 Boy	250	2.50
4407	19/6	19	6.00	2.30 ± 0.20	0.80	1.20 Boy	150	3.40
4408	28/9	28	9.00	2.40 ± 0.20	1.05	1.20 Boy	110	3.90
4409	33/10	33	10.00	2.50 ± 0.20	1.05	1.20 Boy	100	4.60
4410	40/12	40	12.00	2.50 ± 0.20	1.05	1.20 Boy	90	5.20
4411	44/14	44	14.00	2.50 ± 0.20	1.05	1.20 Boy	60	6.00
4412	52/18	52	18.00	2.50 ± 0.20	1.05	1.20 Boy	60	6.80
4414	70/25	70	25.00	3.00 ± 0.30	1.35	1.20 Boy	32	9.00
4415	90/30	90	30.00	3.00 ± 0.30	1.35	1.20 Boy	24	13.00
4416	125/40	125	40.00	3.00 ± 0.30	1.35	1.20 Boy	20	17.00



TEKNİK ÖZELLİKLER

- **Malzeme** : Polyolefin
- **Daralma Oranı** : 3/1
- **Yanmazlık** : Kendi kendine söner
- **Çalışma Sıcaklığı** : -45°C -- +125°C



WWOER®
www.woer.com.tr



- ISI İLE DARALAN MAKARONLAR
- İÇİ YAPIŞKANLI DARALAN MAKARONLAR



KABLO TOPLAMA ÇORABI

Sipariş Kodu	Ölçü	Renk	Esneleme Aralığı		Makara / Mt.	Birim Fiyat USD / Mt.
			Min (mm)	Max (mm)		
4501	3 mm	Siyah	1	6	100	0.17
4502	6 mm	Siyah	3	9	100	0.21
4503	8 mm	Siyah	5	16	100	0.24
4504	10 mm	Siyah	7	19	100	0.28
4505	12 mm	Siyah	8	24	100	0.33
4506	15 mm	Siyah	10	27	100	0.38
4507	20 mm	Siyah	14	30	100	0.45
4508	25 mm	Siyah	18	35	100	0.58
4509	30 mm	Siyah	20	50	50	0.68
4510	40 mm	Siyah	30	60	50	0.90
4511	50 mm	Siyah	40	80	25	1.10

TEKNİK ÖZELLİKLER

- **Malzeme :** Pet (Polyester)
- **Çalışma Sıcaklığı :** -50°C -- +150°C
- **Dayanım Üst Noktası :** 220 °C
- **Erime Noktası :** +250 °C

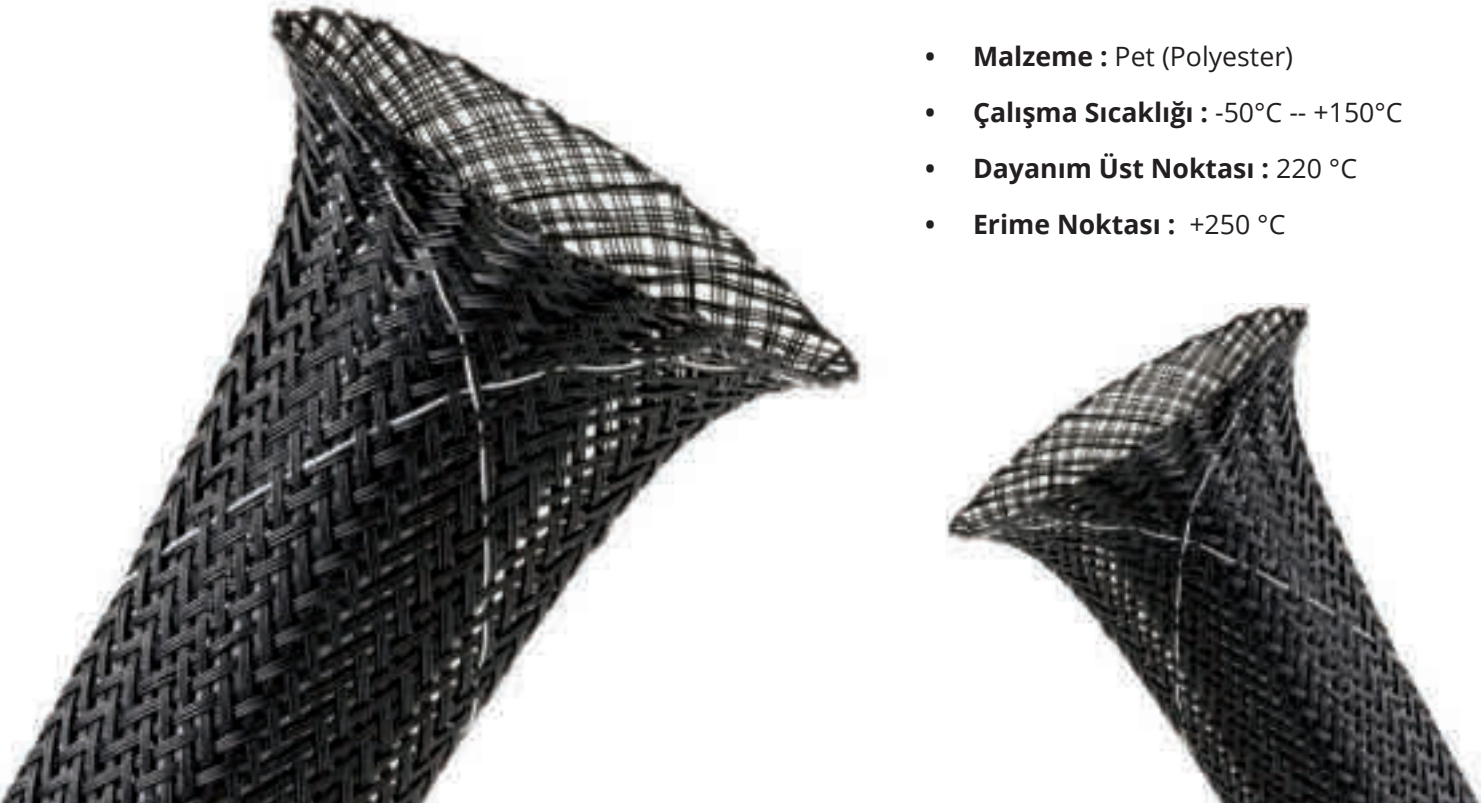

H CLASS CAM ELYAF SİLİKON İZOLELİ MAKARONLAR

Sipariş Kodu	Ölçü	Renk	Makara / Mt.	Koli Miktarı	Birim Fiyat USD / Mt.
4703	2 mm	Kırmızı	200	2.600	0.20
4705	3 mm	Kırmızı	100	2.000	0.26
4706	4 mm	Kırmızı	100	1.500	0.36
4707	5 mm	Kırmızı	100	1.000	0.45
4708	6 mm	Kırmızı	100	1.000	0.52
4709	7 mm	Kırmızı	100	1.000	0.68
4710	8 mm	Kırmızı	50	1.000	0.75
4711	10 mm	Kırmızı	50	600	1.15
4712	12 mm	Kırmızı	50	500	1.25
4713	14 mm	Kırmızı	50	500	1.70
4714	16 mm	Kırmızı	25	500	2.10
4715	18 mm	Kırmızı	25	400	2.50
4716	20 mm	Kırmızı	25	400	3.20
4717	25 mm	Kırmızı	25	350	6.00
4718	30 mm	Kırmızı	25	150	8.80
4719	35 mm	Kırmızı	25	150	11.00



TEKNİK ÖZELLİKLER

- **Malzeme :** Silikon İzoleli Cam Elyaf Örgü Makaron
- **Çalışma Sıcaklığı :** -60 °C -- +250 °C

PVC İZOLELİ CAM ELYAF MAKARONLAR

Sipariş Kodu	Ölçü	Renk	Makara / Mt.	Koli Miktarı	Birim Fiyat USD / Mt.
4604	2 mm	Beyaz Üzeri Çizgili	200	2.400	0.12
4606	3 mm	Beyaz Üzeri Çizgili	100	2.400	0.15
4608	4 mm	Beyaz Üzeri Çizgili	100	2.000	0.19
4609	5 mm	Beyaz Üzeri Çizgili	100	1.400	0.26
4610	6 mm	Beyaz Üzeri Çizgili	100	1.300	0.32
4611	7 mm	Beyaz Üzeri Çizgili	100	1.200	0.36
4612	8 mm	Beyaz Üzeri Çizgili	100	1.000	0.40
4613	10 mm	Beyaz Üzeri Çizgili	50	1.000	0.54
4614	12 mm	Beyaz Üzeri Çizgili	50	1.000	0.68
4615	14 mm	Beyaz Üzeri Çizgili	50	650	0.80
4616	16 mm	Beyaz Üzeri Çizgili	50	600	1.15
4617	18 mm	Beyaz Üzeri Çizgili	50	400	1.30
4618	20 mm	Beyaz Üzeri Çizgili	25	400	1.60



TEKNİK ÖZELLİKLER





- **Malzeme :** PVC İzoleli Cam Elyaf Makaron
- **Çalışma Sıcaklığı :** -20 °C -- +130 °C



ERİYEN BANTLAR

SİPARİŞ KODU	ÜRÜN KODU	ÖLÇÜLER	KOLİ ADET	Birim Fiyat USD / Ad.
4801	GWEST - 1401	19 mm x 0.8 mm x 8 m	60	2.10
4802	GWEST - 1402	50 mm x 0.8 mm x 8 m	24	5.50



İZOLE BANTLAR

	SİPARİŞ KODU	ÜRÜN KODU	ÖLÇÜLER	KOLİ ADET	Birim Fiyat TL / Ad.
	4803	GLOBE	0.13 mm x 19 mm x 9.1 m	500	
	4804	GLOBE	0.50 mm x 50 mm x 9.1 m	60	
	4805	SARI YEŞİL GLOBE	0.13 mm x 19 mm x 9.1 m	500	

	SİPARİŞ KODU	ÜRÜN KODU	ÖLÇÜLER	KOLİ ADET	Birim Fiyat TL / Ad.
	4809	İZOLE BANT	0.13 mm x 19 mm x 9.1 m	500	
	4810	İZOLE BANT	0.50 mm x 50 mm x 9.1 m	36	

SICAK HAVA TABANCASI

	SİPARİŞ KODU	ÜRÜN KODU	GÜÇ	SICAKLIK	KOLİ ADET	Birim Fiyat USD / Ad.
	4903	GW 2000	2000 W	150 / 300 / 500 °C	10	50.00



GÜVEN
ELEKTRİK ELEKTRONİK LTD. ŞTİ.

**MEKANİK
ve
HİDROLİK
EL ALETLERİ**



www.guvenelektrik.com.tr



YÜKSÜK SIKMA PENSELERİ / MEKANİK EL ALETLERİ

Sipariş Kodu: 5026	Ürün Kodu: YYT B-4
0.25 - 6 mm ² Yüksük Sıkma Pensesi	
	
57.00 USD	

Sipariş Kodu: 5005	Ürün Kodu: YAC - 5
0.50 - 6 mm ² Yüksük Sıkma Pensesi	
	
59.00 USD	

Sipariş Kodu: 5006	Ürün Kodu: YAC - 6
6 - 16 mm ² Yüksük Sıkma Pensesi	
	
59.00 USD	

Sipariş Kodu: 5008	Ürün Kodu: YAC - 8
0.08 - 6 mm ² Yüksük Sıkma Pensesi (4 Köşe)	
	
74.00 USD	

Sipariş Kodu: 5009	Ürün Kodu: YAC - 9
0.08 - 6 mm ² Yüksük Sıkma Pensesi (6 Köşe)	
	
97.00 USD	

Sipariş Kodu: 5015	Ürün Kodu: YAC - 17
25 - 35 mm ² Yüksük Sıkma Pensesi	
	
66.00 USD	

Sipariş Kodu: 5024	Ürün Kodu: YYT - 21
0.75 - 10 mm ² Yüksük Sıkma Pensesi	
	
33.00 USD	

Sipariş Kodu: 5025	Ürün Kodu: YYT - 22
0.50 - 2.5 mm ² Yüksük Sıkma Pensesi	
	
32.00 USD	

Sipariş Kodu: 5011	Ürün Kodu: YAC - 11
İzoleli Kablo Ucu ve Yüksük Sıkma Pensesi	
	
70.00 USD	

İZOLESİZ KABLO UCU VE KONNEKTÖR SIKMA PENSELERİ MEKANİK EL ALETLERİ

Sipariş Kodu: 5021	Ürün Kodu: YYT - 11
0.50 - 6 mm ² İzolesiz Terminal Sıkma Pensesi	
	
60.00 USD	

Sipariş Kodu: 5022	Ürün Kodu: YYT - 12
1.00 - 10 mm ² İzolesiz Terminal Sıkma Pensesi	
	
60.00 USD	

Sipariş Kodu: 5014	Ürün Kodu: YAC - 16
Eğri Terminal Sıkma Pensesi	
	
66.00 USD	

Sipariş Kodu: 5012	Ürün Kodu: YAC - 12
28 - 22 / 22 -18 (JST) Konnektör Ucu Sıkma Pensesi (AWG)	
	
63.00 USD	

Sipariş Kodu: 5013	Ürün Kodu: YAC - 13
28 - 22 / 24 -18 (Molex) Konnektör Ucu Sıkma Pensesi (AWG)	
	
63.00 USD	

Sipariş Kodu: 5059	Ürün Kodu: HD - 11010
AWG 24 -14 Konnektör Sıkma Pensesi	
	
55.00 USD	

Sipariş Kodu: 5060	Ürün Kodu: HD - 11011
AWG 30 -18 Konnektör Sıkma Pensesi	
	
55.00 USD	

İZOLELİ KABLO UCU VE KONNEKTÖR SIKMA PENSELERİ MEKANİK EL ALETLERİ

Sipariş Kodu: 5016	Ürün Kodu: YYT - 1
0.50 - 6 mm ² İzoleli Kablo Ucu Sıkma Pensesi	
	
52.00 USD	

Sipariş Kodu: 5017	Ürün Kodu: YYT - 7
0.50 - 6 mm ² İzoleli Kablo Ucu Sıkma Pensesi	
	
60.00 USD	

KONNEKTÖR SIKMA PENSELERİ MEKANİK EL ALETLERİ

Sipariş Kodu: 5065	Ürün Kodu: RJ - 86
6 p / 8 p Konnektör Sıkma Pensesi	
	
52.00 USD	

Sipariş Kodu: 5066	Ürün Kodu: ASA - 486
4 p / 6 p / 8 p Konnektör Sıkma Pensesi	
	
90.00 USD	

Sipariş Kodu: 5002	Ürün Kodu: YAC - 3
0.068 - 0.324 BNC Konnektör Sıkma Pensesi (AWG)	
	
58.00 USD	

Sipariş Kodu: 5063	Ürün Kodu: RG - 9600
AWG 24 -14 Konnektör Sıkma Pensesi	
	
55.00 USD	

MULTİ FONKSİYONEL YÜKSÜK VE KABLO UCU SIKMA PENSESİ

Sipariş Kodu: 5070	Ürün Kodu: T03C - 5D
Takım İçerikli Çanta	
Takım İçeriği YAC 5 Yüksük Sıkma 0.5 - 6 mm YAC 6 Yüksük Sıkma 6 - 16 mm YYT 1 Kablo Ucu Sıkma 0.5 - 6 mm YYT 11 İzolesiz Terminal Sıkma 1 - 4mm YYT 8 Kaynaklı Papuç Sıkma 0.5 - 10mm	
135.00 USD	

KABLO SIYIRICILARI / MEKANİK EL ALETLERİ

Sipariş Kodu: 5037	Ürün Kodu: TP - 700A
0.50 - 2 mm ² Tekli Kablo Sıyırma Pensesi	
	
34.00 USD	

Sipariş Kodu: 5036	Ürün Kodu: TP - 700B
1 - 3.2 mm ² Tekli Kablo Sıyırma Pensesi	
	
34.00 USD	

Sipariş Kodu: 5028	Ürün Kodu: YY - 78 - 318
0.50 - 6 mm ² İzoleli Kablo Ucu Sıkma Pensesi	
	
27.00 USD	

KABLO BAĞI SIKMA PENSELERİ

Sipariş Kodu: 5054	Ürün Kodu: TG - 008
2.2 - 4.8 mm ² Kablo Bağı Sıkma Pensesi	
	
51.00 USD	

Sipariş Kodu: 5055	Ürün Kodu: TG - 009
3.6 - 9 mm ² Kablo Bağı Sıkma Pensesi	
	
34.00 USD	

Sipariş Kodu: 5056	Ürün Kodu: TG - 011
4.6 - 12 mm ² Metal Kablo Bağı Sıkma Pensesi	
	
150.00 USD	

KABLO PAPUCU SIKMA PENSELERİ

Sipariş Kodu: 5018	Ürün Kodu: YYT - 8
1.5 - 10 mm ² SKP Sıkma Pensesi	
	
53.00 USD	

Sipariş Kodu: 5019	Ürün Kodu: YYT - 9
10 - 16 mm ² SKP Sıkma Pensesi	
	
53.00 USD	

Sipariş Kodu: 5057	Ürün Kodu: HD - 25L
6 - 25 mm ² SKP Sıkma Pensesi	
	
81.00 USD	

Sipariş Kodu: 5045	Ürün Kodu: JY - 0650
6 - 50 mm ² SKP Sıkma Pensesi	
	
66.00 USD	

Sipariş Kodu: 5046	Ürün Kodu: JY - 06120
10 - 120 mm ² SKP Sıkma Pensesi	
	
135.00 USD	

Sipariş Kodu: 5047	Ürün Kodu: JY - 25150
25 - 150 mm ² SKP Sıkma Pensesi	
	
140.00 USD	

HİDROLİK SIKMA VE KESME PENSELERİ

Sipariş Kodu: 5050	Ürün Kodu: YYQ 120
10 - 120 mm ² Hidrolik SKP Sıkma Pensesi (Çantalı Set)	
	
140.00 USD	

Sipariş Kodu: 5051	Ürün Kodu: YQK 300
16 - 300 mm ² Hidrolik SKP Sıkma Pensesi (Çantalı Set)	
	
150.00 USD	

Sipariş Kodu: 5052	Ürün Kodu: CPC - 40A
Kesme Kuvveti 6 Ton, Kesme Kapasitesi 32mm ² Cu/Alu	
	
340.00 USD	

Sipariş Kodu: 5053	Ürün Kodu: CPC - 50A
Kesme Kuvveti 6 Ton, Kesme Kapasitesi 45mm ² Cu/Alu	
	
400.00 USD	

KABLO KESME MAKASLARI

Sipariş Kodu: 5038	Ürün Kodu: CC- 22
25 mm ² Kablo Kesme Makası	
	
22.00 USD	

Sipariş Kodu: 5039	Ürün Kodu: CC- 38
50 mm ² Kablo Kesme Makası	
	
25.00 USD	

Sipariş Kodu: 5040	Ürün Kodu: CC- 60
60 mm ² Kablo Kesme Makası	
	
33.00 USD	

Sipariş Kodu: 5041	Ürün Kodu: TC- 100
120 mm ² Kablo Kesme Makası	
	
58.00 USD	

Sipariş Kodu: 5042	Ürün Kodu: TC- 250
250 mm ² Kablo Kesme Makası	
	
107.00 USD	

Sipariş Kodu: 5044	Ürün Kodu: TC - 500
630 mm ² Kablo Kesme Makası	
	
165.00 USD	

Sipariş Kodu: 5067	Ürün Kodu: TCR- 325
325 mm ² Bakır ve Alüminyum Kablo Kesme Makası	
	
165.00 USD	

Sipariş Kodu: 5068	Ürün Kodu: ZC - 60A
500 mm ² Bakır ve Alüminyum Kablo Kesme Makası	
	
230.00 USD	

Sipariş Kodu: 5069	Ürün Kodu: ZCR - 52
500 mm ² Çok Telli Kablo Kesme Makası	
	
280.00 USD	



GÜVEN
ELEKTRİK ELEKTRONİK LTD. ŞTİ.

BUTON SERİSİ ve AKSESUARLARI











www.guvenelektrik.com.tr



Q 22mm BUTON SERİSİ



















YAYLI BUTONLAR

	SİPARİŞ KODU	ÜRÜN KODU	KONTAK	AÇIKLAMA	RENK	KUTU ADET	KOLİ ADET	Birim Fiyat TL / Ad.
 	6001	A5 - 10	1NO	Yaylı Buton	 Yeşil	10	300	11.00
	6002	A5 - 01	1NC	Yaylı Buton	 Kırmızı	10	300	11.00
	6003	A5 - 11	1NO	Yaylı Buton	 Sarı	10	300	11.00
	6004	A5 - 21	1NO	Yaylı Buton	 Mavi	10	300	11.00
	6005	A5 - 31	1NO	Yaylı Buton	 Beyaz	10	300	11.00
	6006	A5 - 41	1NO	Yaylı Buton	 Siyah	10	300	11.00

İŞARETLİ YAYLI BUTONLAR



	6007	A5 - 10/1	1NO	İşaretlili Yaylı Buton		10	300	12.50
	6008	A5 - 01/2	1NC	İşaretlili Yaylı Buton		10	300	12.50
	6009	A5 - 10/3	1NO	İşaretlili Yaylı Buton		10	300	12.50
	6010	A5 - 10/4	1NO	İşaretlili Yaylı Buton		10	300	12.50

İŞIKLI YAYLI BUTONLAR



	6011	A5 - 10D	1NO	Işıklı Yaylı Buton 220V AC/DC	 Yeşil	10	300	22.00
	6012	A5 - 01D	1NC		 Kırmızı	10	300	22.00
	6013	A5 - 11D	1NO		 Sarı	10	300	22.00
	6014	A5 - 21D	1NO		 Mavi	10	300	22.00
	6015	A5 - 31D	1NO		 Beyaz	10	300	22.00
	6016	A5 - 10D-110	1NO	Işıklı Yaylı Buton 110V AC/DC	 Yeşil	10	300	22.00
	6017	A5 - 01D-110	1NC		 Kırmızı	10	300	22.00
	6018	A5 - 11D-110	1NO		 Sarı	10	300	22.00
	6019	A5 - 21D-110	1NO		 Mavi	10	300	22.00
	6020	A5 - 31D-110	1NO		 Beyaz	10	300	22.00
	6021	A5 - 10D-24	1NO	Işıklı Yaylı Buton 24V AC/DC	 Yeşil	10	300	22.00
	6022	A5 - 01D-24	1NC		 Kırmızı	10	300	22.00
	6023	A5 - 11D-24	1NO		 Sarı	10	300	22.00
	6024	A5 - 21D-24	1NO		 Mavi	10	300	22.00
	6025	A5 - 31D-24	1NO		 Beyaz	10	300	22.00

Q 22mm BUTON SERİSİ

KALICI MANDAL BUTONLAR

	SİPARİŞ KODU	ÜRÜN KODU	KONTAK	AÇIKLAMA	KUTU ADET	KOLİ ADET	Birim Fiyat TL / Ad.
	6027	A5 - 10X	1NO	0 -1 Mandal Buton 	10	300	12.00
	6028	A5 - 20XS	2NO	1-0-2 Mandal Buton 	10	300	17.00



KAYICI MANDAL BUTONLAR

	SİPARİŞ KODU	ÜRÜN KODU	KONTAK	AÇIKLAMA	KUTU ADET	KOLİ ADET	Birim Fiyat TL / Ad.
	6029	A5 - 10X/FU	1NO	0 -1 Mandal Buton 	10	300	14.00
	6030	A5 - 20XS/FU	2NO	1-0-2 Mandal Buton 	10	300	20.00

KALICI - KAYICI MANDAL BUTON

	SİPARİŞ KODU	ÜRÜN KODU	KONTAK	AÇIKLAMA	KUTU ADET	KOLİ ADET	Birim Fiyat TL / Ad.
	6026	A5 - 20XS/F	2NO	1-0-2 Mandal Buton Sağ Pozisyon Kalıcı Sol Pozisyon Kayıcı 	10	300	19.00

ANAHTARLI KALICI BUTONLAR

	SİPARİŞ KODU	ÜRÜN KODU	KONTAK	AÇIKLAMA	KUTU ADET	KOLİ ADET	Birim Fiyat TL / Ad.
	6049	A5 - 10Y	1NO	0 -1 Anahtarlı Buton 	10	300	23.00
	6050	A5 - 20YS	2NO	1-0-2 Anahtarlı Buton 	10	300	28.00

Q 22mm BUTON SERİSİ

	SİPARİŞ KODU	ÜRÜN KODU	KONTAK	AÇIKLAMA	RENK	KUTU ADET	KOLİ ADET	Birim Fiyat TL / Ad.
	6031	A5 - 10XD	1NO	 0-1 Işıklı Mandal Buton 220V AC/DC	 Yeşil	10	300	23.00
	6032	A5 - 01XD	1NC		 Kırmızı	10	300	
	6033	A5 - 11XD	1NO		 Sarı	10	300	
	6037	A5 - 10XD-110	1NO	 0-1 Işıklı Mandal Buton 110V AC/DC	 Yeşil	10	300	23.00
	6038	A5 - 01XD-110	1NC		 Kırmızı	10	300	
	6039	A5 - 11XD-110	1NO		 Sarı	10	300	
	6043	A5 - 10XD-24	1NO	 0-1 Işıklı Mandal Buton 24V AC/DC	 Yeşil	10	300	23.00
	6044	A5 - 01XD-24	1NC		 Kırmızı	10	300	
	6045	A5 - 11XD-24	1NO		 Sarı	10	300	
	6034	A5 - 20XSD	2NO	 1-0-2 Işıklı Mandal Buton 220V AC/DC	 Yeşil	10	300	28.00
	6035	A5 - 02XSD	2NC		 Kırmızı	10	300	
	6036	A5 - 21XSD	2NO		 Sarı	10	300	
	6040	A5 - 20XSD-110	2NO	 1-0-2 Işıklı Mandal Buton 110V AC/DC	 Yeşil	10	300	28.00
	6041	A5 - 02XSD-110	2NC		 Kırmızı	10	300	
	6042	A5 - 21XSD-110	2NO		 Sarı	10	300	
	6046	A5 - 20XSD-24	2NO	 1-0-2 Işıklı Mandal Buton 24V AC/DC	 Yeşil	10	300	28.00
	6047	A5 - 02XSD-24	2NC		 Kırmızı	10	300	
	6048	A5 - 21XSD-24	2NO		 Sarı	10	300	

Q 22mm BUTON SERİSİ

40mm KALICI MANTAR BUTON

	SİPARİŞ KODU	ÜRÜN KODU	KONTAK	AÇIKLAMA	RENK	KUTU ADET	KOLİ ADET	Birim Fiyat TL / Ad.
	6054	A5 - 01ZS	1NC	Stop Mantar Buton	 Kırmızı	10	300	14.00

40mm KALICI ANAHTARLI MANTAR BUTON

	SİPARİŞ KODU	ÜRÜN KODU	KONTAK	AÇIKLAMA	RENK	KUTU ADET	KOLİ ADET	Birim Fiyat TL / Ad.
	6075	BZ - 01ZA	1NC	Anahtarlı Stop Mantar Buton	 Kırmızı	10	300	22.00

40mm KAYICI MANTAR BUTONLAR





	SİPARİŞ KODU	ÜRÜN KODU	KONTAK	AÇIKLAMA	RENK	KUTU ADET	KOLİ ADET	Birim Fiyat TL / Ad.
	6051	A5 - 01M	1NC	Stop Mantar Buton	 Kırmızı	10	300	12.50
	6052	A5 - 10M	1NO	Start Mantar Buton	 Yeşil	10	300	12.50
	6053	A5 - 41M	1NO	Start Mantar Buton	 Siyah	10	300	12.50





40mm KALICI MANTAR BUTONLAR





	SİPARİŞ KODU	ÜRÜN KODU	KONTAK	AÇIKLAMA	RENK	KUTU ADET	KOLİ ADET	Birim Fiyat TL / Ad.
	6055	A5 - 01ZF	1NC	Stop Mantar Buton		10	300	25.00
	6058	A5 - 01ZFD	1NC	Led Işıklı Stop Mantar Buton 220V AC/DC		10	300	34.00
	6057	A5 - 01ZFD-110	1NC	Led Işıklı Stop Mantar Buton 110V AC/DC		10	300	34.00
	6056	A5 - 01ZFD-24	1NC	Led Işıklı Stop Mantar Buton 24V AC		10	300	34.00





Q 22mm BUTON SERİSİ

İKİZ BUTONLAR

	SİPARİŞ KODU	ÜRÜN KODU	KONTAK	AÇIKLAMA	RENK	KUTU ADET	KOLİ ADET	Birim Fiyat TL / Ad.
	6063	A1 - 11R	1NO+1NC	İkiz Buton	 Yeşil - Kırmızı	10	300	17.50
	6066	A1 - 11RD	1NO+1NC	Işıklı İkiz Buton 220V AC/DC	 Yeşil - Kırmızı	10	300	27.00
	6067	A1 - 11RD-110	1NO+1NC	Işıklı İkiz Buton 110V AC/DC	 Yeşil - Kırmızı	10	300	27.00
	6068	A1 - 11RD-24	1NO+1NC	Işıklı İkiz Buton 24V AC/DC	 Yeşil - Kırmızı	10	300	27.00

	6059	A5 - 11R	1NO+1NC	İkiz Buton	 Yeşil - Kırmızı	10	300	20.00
	6062	A5 - 11RD	1NO+1NC	Işıklı İkiz Buton 220V AC/DC	 Kırmızı - Yeşil	10	300	30.00
	6061	A5 - 11RD-110	1NO+1NC	Işıklı İkiz Buton 110V AC/DC	 Kırmızı - Yeşil	10	300	30.00
	6060	A5 - 11RD-24	1NO+1NC	Işıklı İkiz Buton 24V AC/DC	 Kırmızı - Yeşil	10	300	30.00







	6064	A1 - 11R/5	1NO+1NC	1-0 İşaretli İkiz Buton	 Beyaz - Siyah	10	300	18.50
	6069	A1 - 11RD/5	1NO+1NC	1-0 Işıklı İkiz Buton 220V AC/DC	 Beyaz - Siyah	10	300	28.00
	6070	A1 - 11RD/5-110	1NO+1NC	1-0 Işıklı İkiz Buton 110V AC/DC	 Beyaz - Siyah	10	300	28.00
	6071	A1 - 11RD/5-24	1NO+1NC	1-0 Işıklı İkiz Buton 24V AC/DC	 Beyaz - Siyah	10	300	28.00

	6065	A1 - 11R/6	1NO+1NC	ON-OFF İkiz Buton	 Beyaz - Siyah	10	300	18.50
	6072	A1 - 11RD/6	1NO+1NC	Işıklı İkiz Buton 220V AC/DC	 Beyaz - Siyah	10	300	28.00
	6073	A1 - 11RD/6-110	1NO+1NC	Işıklı İkiz Buton 110V AC/DC	 Beyaz - Siyah	10	300	28.00
	6074	A1 - 11RD/6-24	1NO+1NC	Işıklı İkiz Buton 24V AC/DC	 Kırmızı - Yeşil	10	300	28.00

BUTON AKSESUARLARI

	SİPARİŞ KODU	ÜRÜN KODU	AÇIKLAMA	KUTU ADET	Birim Fiyat TL / Ad.
	6101	A - 10	1NO Start Kontakt	250	5.50
	6102	A - 01	1NO Stop Kontakt	250	5.50
	6103	A - D2	BA9S Led Kontakt Yuvası (Buton için)	200	5.50
	6104	FC	Plastik Buton Rozeti	100	1.00
	6105	FD/60	60mm Acil Stop Etiketi	100	3.00
	6106	EC5-1	Acil Stop Butonu Koruma Kapağı	20	11.00
	6107	FH	Buton Koruma Kapağı	3	10.00
	6108	BK	Buton Koruma Kılıfı	100	2.00





BOŞ BUTON KUTULARI

	SİPARİŞ KODU	ÜRÜN KODU	AÇIKLAMA	RENK	KUTU ADET	KOLİ ADET	Birim Fiyat TL / Ad.
	6114	GBK - 1	1'li Boş Kumanda Kutusu	Sarı-Siyah	1	100	7.00
	6116	GBK - 2	2'li Boş Kumanda Kutusu	Sarı-Siyah	1	100	9.50
	6118	GBK - 3	3'li Boş Kumanda Kutusu	Sarı-Siyah	1	100	11.00
	6120	GBK - 4	4'li Boş Kumanda Kutusu	Sarı-Siyah	1	50	14.50
	6122	GBK - 5	5'li Boş Kumanda Kutusu	Sarı-Siyah	1	50	22.00
	6124	GBK - 6	6'li Boş Kumanda Kutusu	Sarı-Siyah	1	50	23.00





KUTULU ACİL STOP BUTON

	SİPARİŞ KODU	ÜRÜN KODU	KONTAK	AÇIKLAMA	RENK	KUTU ADET	KOLİ ADET	Birim Fiyat TL / Ad.
	6125	LAY2 - KSE542	NC	1'li Mantar Acil Stop Buton	Sarı-Siyah	1	100	19.00

Ø 22mm VOLTMETRE

	SİPARİŞ KODU	ÜRÜN KODU	ÇAP (mm)	AÇIKLAMA	RENK	KUTU ADET	KOLİ ADET	Birim Fiyat TL / Ad.
	6501	22 VS - K	22	24 - 550V Led'li Voltmetre	● Kırmızı	10	500	17.00
	6502	22 VS - Y	22	24 - 550V Led'li Voltmetre	● Yeşil	10	500	17.00
	6503	22 VS - S	22	24 - 550V Led'li Voltmetre	● Sarı	10	500	17.00
	6504	22 VS - M	22	24 - 550V Led'li Voltmetre	● Mavi	10	500	18.00
	6505	22 VS - B	22	24 - 550V Led'li Voltmetre	○ Beyaz	10	500	18.00

Ø 22mm AMPERMETRE

	SİPARİŞ KODU	ÜRÜN KODU	ÇAP (mm)	AÇIKLAMA	RENK	KUTU ADET	KOLİ ADET	Birim Fiyat TL / Ad.
	6511	22 - AS -K	22	0 - 100A Led'li Ampermetre Akım Trafolu	● Kırmızı	1	300	35.00
	6512	23 - AS -Y	22	0 - 100A Led'li Ampermetre Akım Trafolu	● Yeşil	1	300	35.00
	6513	24 - AS -S	22	0 - 100A Led'li Ampermetre Akım Trafolu	● Sarı	1	300	35.00
	6514	25 - AS - M	22	0 - 100A Led'li Ampermetre Akım Trafolu	● Mavi	1	300	37.00
	6515	26 - AS -B	22	0 - 100A Led'li Ampermetre Akım Trafolu	○ Beyaz	1	300	37.00

Ø 22mm LED'Lİ SİNYALLER



SİPARİŞ KODU	ÜRÜN KODU	ÇAP (mm)	AÇIKLAMA	RENK	KUTU ADET	KOLİ ADET	Birim Fiyat TL / Ad.
6601	22 - K	22	Led Sinyal 220V. AC-DC	● Kırmızı	10	500	3.80
6602	22 - Y	22	Led Sinyal 220V. AC-DC	● Yeşil	10	500	3.80
6603	22 - S	22	Led Sinyal 220V. AC-DC	● Sarı	10	500	3.80
6604	22 - M	22	Led Sinyal 220V. AC-DC	● Mavi	10	500	4.40
6605	22 - B	22	Led Sinyal 220V. AC-DC	○ Beyaz	10	500	4.40
6606	22 - 110V - K	22	Led Sinyal 110V. AC-DC	● Kırmızı	10	500	3.80
6607	22 - 110V - Y	22	Led Sinyal 110V. AC-DC	● Yeşil	10	500	3.80
6608	22 - 110V - S	22	Led Sinyal 110V. AC-DC	● Sarı	10	500	3.80
6609	22 - 110V - M	22	Led Sinyal 110V. AC-DC	● Mavi	10	500	4.40
6610	22 - 110V - B	22	Led Sinyal 110V. AC-DC	○ Beyaz	10	500	4.40
6611	22 - 24V - K	22	Led Sinyal 24V. AC-DC	● Kırmızı	10	500	3.80
6612	22 - 24V - Y	22	Led Sinyal 24V. AC-DC	● Yeşil	10	500	3.80
6613	22 - 24V - S	22	Led Sinyal 24V. AC-DC	● Sarı	10	500	3.80
6614	22 - 24V - M	22	Led Sinyal 24V. AC-DC	● Mavi	10	500	4.40
6615	22 - 24V - B	22	Led Sinyal 24V. AC-DC	○ Beyaz	10	500	4.40

Ø 16mm LED'Lİ SİNYALLER



SİPARİŞ KODU	ÜRÜN KODU	ÇAP (mm)	AÇIKLAMA	RENK	KUTU ADET	KOLİ ADET	Birim Fiyat TL / Ad.
6621	16 - K	16	Led Sinyal 220V. AC-DC	● Kırmızı	20	1.000	6.50
6622	16 - Y	16	Led Sinyal 220V. AC-DC	● Yeşil	20	1.000	6.50
6623	16 - S	16	Led Sinyal 220V. AC-DC	● Sarı	20	1.000	6.50
6624	16 - M	16	Led Sinyal 220V. AC-DC	● Mavi	20	1.000	7.30
6625	16 - B	16	Led Sinyal 220V. AC-DC	○ Beyaz	20	1.000	7.30
6626	16 - 110V - K	16	Led Sinyal 110V. AC-DC	● Kırmızı	20	1.000	6.50
6627	16 - 110V - Y	16	Led Sinyal 110V. AC-DC	● Yeşil	20	1.000	6.50
6628	16 - 110V - S	16	Led Sinyal 110V. AC-DC	● Sarı	20	1.000	6.50
6629	16 - 110V - M	16	Led Sinyal 110V. AC-DC	● Mavi	20	1.000	7.30
6630	16 - 110V - B	16	Led Sinyal 110V. AC-DC	○ Beyaz	20	1.000	7.30
6631	16 - 24V - K	16	Led Sinyal 24V. AC-DC	● Kırmızı	20	1.000	6.50
6632	16 - 24V - Y	16	Led Sinyal 24V. AC-DC	● Yeşil	20	1.000	6.50
6633	16 - 24V - S	16	Led Sinyal 24V. AC-DC	● Sarı	20	1.000	6.50
6634	16 - 24V - M	16	Led Sinyal 24V. AC-DC	● Mavi	20	1.000	7.30
6635	16 - 24V - B	16	Led Sinyal 24V. AC-DC	○ Beyaz	20	1.000	7.30

BA9S LED AMPULLER



SİPARİŞ KODU	ÜRÜN KODU	AÇIKLAMA	RENK	KUTU ADET	KOLİ ADET	Birim Fiyat TL / Ad.
6521	BA9SC - K	Led Ampul 220V. AC-DC	● Kırmızı	50	4.000	6.00
6522	BA9SC - Y	Led Ampul 220V. AC-DC	● Yeşil	50	4.000	6.00
6523	BA9SC - S	Led Ampul 220V. AC-DC	● Sarı	50	4.000	6.00
6524	BA9SC - M	Led Ampul 220V. AC-DC	● Mavi	50	4.000	8.00
6525	BA9SC - B	Led Ampul 220V. AC-DC	○ Beyaz	50	4.000	8.00
6526	BA9SC - 110V - K	Led Ampul 110V. AC-DC	● Kırmızı	50	4.000	6.00
6527	BA9SC - 110V - Y	Led Ampul 110V. AC-DC	● Yeşil	50	4.000	6.00
6528	BA9SC - 110V - S	Led Ampul 110V. AC-DC	● Sarı	50	4.000	6.00
6529	BA9SC - 110V - M	Led Ampul 110V. AC-DC	● Mavi	50	4.000	8.00
6530	BA9SC - 110V - B	Led Ampul 110V. AC-DC	○ Beyaz	50	4.000	8.00
6531	BA9SC - 24V - K	Led Ampul 24V. AC-DC	● Kırmızı	50	4.000	6.00
6532	BA9SC - 24V - Y	Led Ampul 24V. AC-DC	● Yeşil	50	4.000	6.00
6533	BA9SC - 24V - S	Led Ampul 24V. AC-DC	● Sarı	50	4.000	6.00
6534	BA9SC - 24V - M	Led Ampul 24V. AC-DC	● Mavi	50	4.000	8.00
6535	BA9SC - 24V - B	Led Ampul 24V. AC-DC	○ Beyaz	50	4.000	8.00

METAL LED'Lİ SİNYALLER



SİPARİŞ KODU	ÜRÜN KODU	ÇAP (mm)	AÇIKLAMA	RENK	KUTU ADET	KOLİ ADET	Birim Fiyat TL / Ad.
6551	C8 - K	8	Metal Led Sinyal 220V. AC-DC	● Kırmızı	50	600	9.00
6552	C8 - Y	8		● Yeşil	50	600	9.00
6553	C8 - S	8		● Sarı	50	600	9.00
6554	C8 - M	8		● Mavi	50	600	9.00
6555	C8 - B	8		○ Beyaz	50	600	9.00
6556	C8 - 24V - K	8	Metal Led Sinyal 24V. AC-DC	● Kırmızı	50	600	9.00
6557	C8 - 24V - Y	8		● Yeşil	50	600	9.00
6558	C8 - 24V - S	8		● Sarı	50	600	9.00
6559	C8 - 24V - M	8		● Mavi	50	600	9.00
6560	C8 - 24V - B	8		○ Beyaz	50	600	9.00
6561	C10 - K	10	Metal Led Sinyal 220V. AC-DC	● Kırmızı	30	360	11.00
6562	C10 - Y	10		● Yeşil	30	360	11.00
6563	C10 - S	10		● Sarı	30	360	11.00
6564	C10 - M	10		● Mavi	30	360	11.00
6565	C10 - B	10		○ Beyaz	30	360	11.00
6566	C10 - 24V - K	10	Metal Led Sinyal 24V. AC-DC	● Kırmızı	30	360	11.00
6567	C10 - 24V - Y	10		● Yeşil	30	360	11.00
6568	C10 - 24V - S	10		● Sarı	30	360	11.00
6569	C10 - 24V - M	10		● Mavi	30	360	11.00
6570	C10 - 24V - B	10		○ Beyaz	30	360	11.00
6571	C14 - K	14	Metal Led Sinyal 220V. AC-DC	● Kırmızı	15	180	20.00
6572	C14 - Y	14		● Yeşil	15	180	20.00
6573	C14 - S	14		● Sarı	15	180	20.00
6574	C14 - M	14		● Mavi	15	180	20.00
6575	C14 - B	14		○ Beyaz	15	180	20.00
6576	C14 - 24V - K	14	Metal Led Sinyal 24V. AC-DC	● Kırmızı	15	180	20.00
6577	C14 - 24V - Y	14		● Yeşil	15	180	20.00
6578	C14 - 24V - S	14		● Sarı	15	180	20.00
6579	C14 - 24V - M	14		● Mavi	15	180	20.00
6580	C14 - 24V - B	14		○ Beyaz	15	180	20.00

BUZZER'LAR

Ø 22mm LED'Lİ BUZZER (90dB)



SİPARİŞ KODU	ÜRÜN KODU	ÇAP (mm)	AÇIKLAMA	RENK	KUTU ADET	KOLİ ADET	Birim Fiyat TL / Ad.
6640	22DS/MS	22	Sesli Led Flaşör İkazlı 220V. AC/DC	● Kırmızı	10	500	19.00
6641	22DS/MS24	22	Sesli Led Flaşör İkazlı 24V. AC/DC	● Kırmızı	10	500	19.00

Ø 22mm SESLİ BUZZER (90dB)



SİPARİŞ KODU	ÜRÜN KODU	ÇAP (mm)	AÇIKLAMA	RENK	KUTU ADET	KOLİ ADET	Birim Fiyat TL / Ad.
6642	22DS/M	22	Sesli İkazlı 220V. AC/DC	● Siyah	10	500	18.00
6643	22DS/M24	22	Sesli İkazlı 24V. AC/DC	● Siyah	10	500	18.00

MOTORLU SİRENLER



SİPARİŞ KODU	ÜRÜN KODU	AÇIKLAMA	KUTU ADET	KOLİ ADET	Birim Fiyat TL / Ad.
6651	MS - 190 - 220	75mm Metal Gövde 220V. AC (110 - 130dB)	1	40	75.00
6652	MS - 190 - 24	75mm Metal Gövde 24V. AC (110 - 130dB)	1	40	75.00

ELEKTRONİK SİRENLER

ES-50
ES-60

SİPARİŞ KODU	ÜRÜN KODU	AÇIKLAMA	KUTU ADET	KOLİ ADET	Birim Fiyat TL / Ad.
6656	ES - 50 - 12/24	Plastik Gövde 120dB 12-24V. AC/DC	1	100	38.00
6658	ES - 60 - 220	Plastik Gövde 120dB 220V. AC	1	100	65.00
6657	ES - 60 - 12/24	Plastik Gövde 120dB 12-24V. AC	1	100	50.00

Ø 22mm POTANSİYOMETRE



SİPARİŞ KODU	ÜRÜN KODU	ÇAP (mm)	AÇIKLAMA	KUTU ADET	KOLİ ADET	Birim Fiyat TL / Ad.
6665	APT22 - 5K	22	5K Potansiyometre Tek Turlu 220V. AC	10	500	45.00
6666	APT22 - 10K	22	10K Potansiyometre Tek Turlu 220V. AC	10	500	45.00

PANO İÇİ TERMOSTATLAR

Çalışma Ömrü : 100.000 Açma Kapama

Ölçüler : 60x33x43

Ağırlık : 40 gr

Koruma Sınıfı : IP20



SİPARİŞ KODU	ÜRÜN KODU	KONTAK	AÇIKLAMA ve ÇALIŞMA SICAKLIĞI	KUTU ADET	KOLİ ADET	Birim Fiyat TL / Ad.
6682	KTO - 011	NC	Isıtma Termostatı (0 - 60°C)	1	300	34.00
6681	KTS - 011	NO	Soğutma Termostatı (0 - 60°C)	1	300	34.00





AKS SERİSİ KAPI SİVİÇLERİ







SİPARİŞ KODU	ÜRÜN KODU	KONTAK	AÇIKLAMA	KUTU ADET	KOLİ ADET	Birim Fiyat TL / Ad.
6825	AKS - 10	NO	Açık Kontak Kapı Sivici	50	500	9.00
6826	AKS - 01	NC	Kapalı Kontak Kapı Sivici	50	500	9.00

VİNÇ KUMANDA BUTONLARI

PLASTİK VİNÇ KUMANDALAR (IP67)

	SİPARİŞ KODU	ÜRÜN KODU	AÇIKLAMA	KUTU ADET	KOLİ ADET	Birim Fiyat USD / Ad.
	6701	VK - 2	Plastik Vinç Kumanda 2'li Tek Hızlı	1	72	4.40
	6702	VK - 4	Plastik Vinç Kumanda 4'li Tek Hızlı	1	48	5.70
	6703	VK - 6	Plastik Vinç Kumanda 6'li Tek Hızlı	1	42	7.50
	6704	VK - 8	Plastik Vinç Kumanda 8'li Tek Hızlı	1	36	10.00

ACİL STOPLU PLASTİK VİNÇ KUMANDALAR (IP67)

	6705	VKB - 3	Plastik Vinç Kumanda 3'li Tek Hızlı	1	50	17.50
	6706	VKB - 5	Plastik Vinç Kumanda 5'li Tek Hızlı	1	40	24.00
	6707	VKB - 7	Plastik Vinç Kumanda 7'li Tek Hızlı	1	30	31.00
	6708	VKB - 9	Plastik Vinç Kumanda 9'li Tek Hızlı	1	20	38.00



GÜVEN
ELEKTRİK ELEKTRONİK LTD. ŞTİ.

SWITCH GRUBU



www.guvenelektrik.com.tr



GLS SERİSİ LİMİT SWITCH

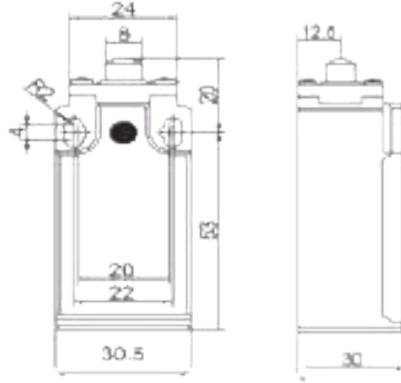

Birim Fiyat USD / Ad.	5.00
SİPARİŞ KODU	6801
ÜRÜN KODU	GLS -101
KUTU ADET	10
KOLİ ADETİ	100
AÇIKLAMA	Kısa Dikey Metal Pim 1NO + 1NC

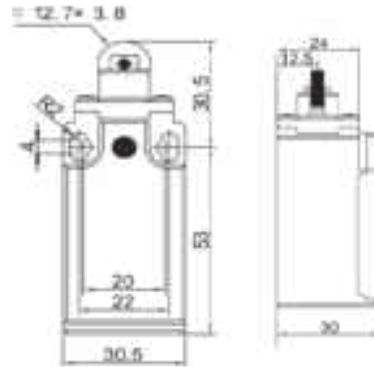

Birim Fiyat USD / Ad.	5.00
SİPARİŞ KODU	6802
ÜRÜN KODU	GLS -103
KUTU ADET	10
KOLİ ADETİ	100
AÇIKLAMA	Dikey Metal Makaralı 1NO + 1NC

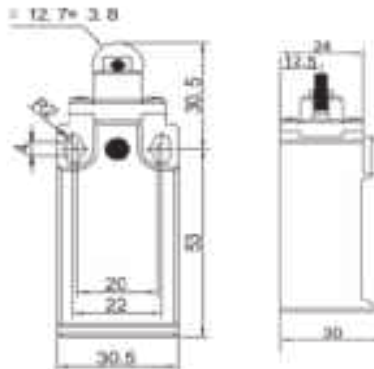

Birim Fiyat USD / Ad.	5.20
SİPARİŞ KODU	6803
ÜRÜN KODU	GLS -103R
KUTU ADET	10
KOLİ ADETİ	100
AÇIKLAMA	Dikey Metal Makaralı Resetli 1NO + 1NC

RESETLİ

GLS SERİSİ LİMİT SWITCH

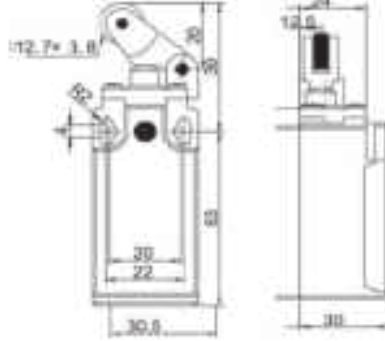

Birim Fiyat USD / Ad.	5.00
SİPARİŞ KODU	6804
ÜRÜN KODU	GLS -111
KUTU ADET	10
KOLİ ADETİ	100
AÇIKLAMA	Açısal Metal Makaralı Tek Yön 1NO + 1NC

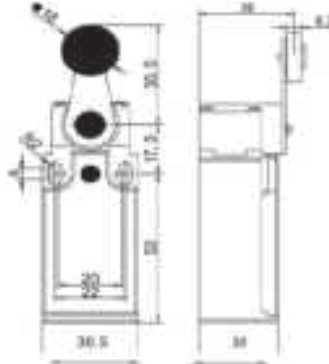

Birim Fiyat USD / Ad.	5.00
SİPARİŞ KODU	6805
ÜRÜN KODU	GLS -121
KUTU ADET	10
KOLİ ADETİ	100
AÇIKLAMA	Dikey Metal Makaralı Çift Yön 1NO + 1NC

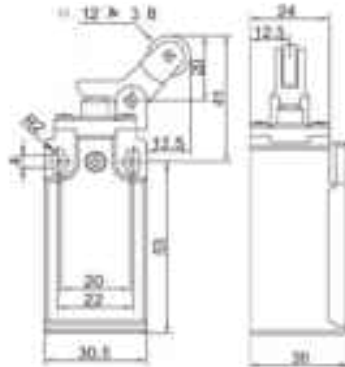

Birim Fiyat USD / Ad.	5.00
SİPARİŞ KODU	6806
ÜRÜN KODU	GLS -127
KUTU ADET	10
KOLİ ADETİ	100
AÇIKLAMA	Ters Açısal Metal Makaralı Tek Yön 1NO + 1NC

GLS SERİSİ LİMİT SWITCH

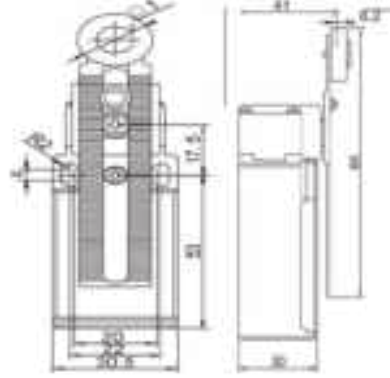

Birim Fiyat USD / Ad.	5.20
SİPARİŞ KODU	6807
ÜRÜN KODU	GLS -131
KUTU ADET	10
KOLİ ADETİ	100
AÇIKLAMA	Ayarlanabilir Metal Makaralı Çift Yön 1NO + 1NC

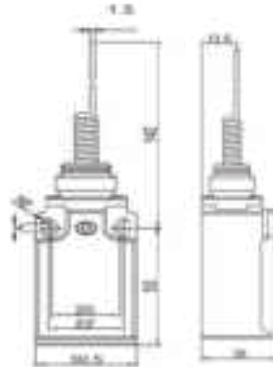

Birim Fiyat USD / Ad.	5.20
SİPARİŞ KODU	6808
ÜRÜN KODU	GLS -161
KUTU ADET	10
KOLİ ADETİ	100
AÇIKLAMA	Çok Yönlü Spiral Tel Uç 1NO + 1NC

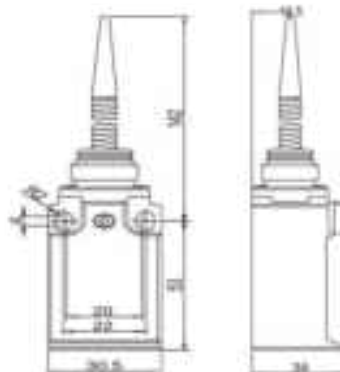

Birim Fiyat USD / Ad.	5.20
SİPARİŞ KODU	6809
ÜRÜN KODU	GLS -171
KUTU ADET	10
KOLİ ADETİ	100
AÇIKLAMA	Çok Yönlü Spiral Plastik Uç 1NO + 1NC

GLS SERİSİ LİMİT SWITCH

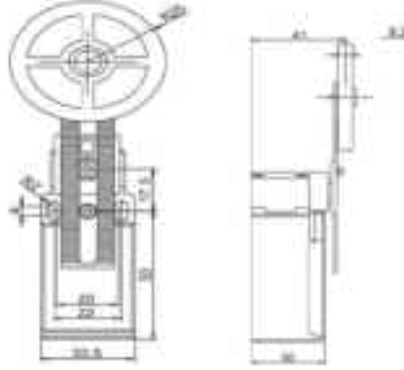

Birim Fiyat USD / Ad.	5.20
SİPARİŞ KODU	6810
ÜRÜN KODU	GLS -191
KUTU ADET	1
KOLİ ADETİ	50
AÇIKLAMA	Ayarlanabilir Kauçuk Makara Çift Yön 1NO + 1NC



RESETLİ

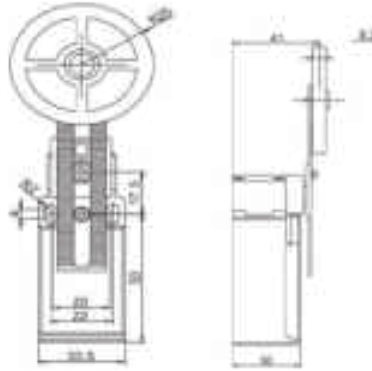

Birim Fiyat USD / Ad.	6.50
SİPARİŞ KODU	6800
ÜRÜN KODU	GLS -191R
KUTU ADET	1
KOLİ ADETİ	50
AÇIKLAMA	Ayarlanabilir Kauçuk Makara Çift Yön Resetli 1NO + 1NC



AZ SERİSİ MİKRO SWITCH

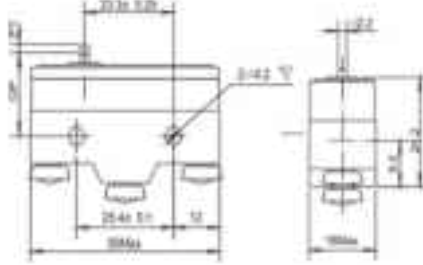

Birim Fiyat USD / Ad.	2.70
SİPARİŞ KODU	6811
ÜRÜN KODU	AZ - 15G - B
KUTU ADET	20
KOLİ ADETİ	360
AÇIKLAMA	İnce Kısa Pimli 15A 1NO + 1NC

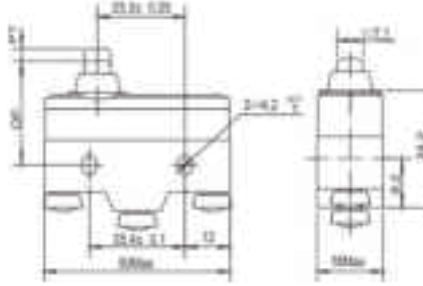

Birim Fiyat USD / Ad.	2.70
SİPARİŞ KODU	6812
ÜRÜN KODU	AZ - 15GD - B
KUTU ADET	20
KOLİ ADETİ	360
AÇIKLAMA	Kalın Uzun Pimli 15A 1NO + 1NC

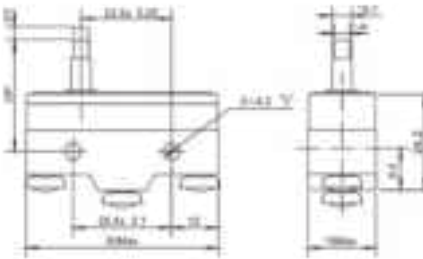

Birim Fiyat USD / Ad.	3.10
SİPARİŞ KODU	6813
ÜRÜN KODU	AZ - 15GS - B
KUTU ADET	20
KOLİ ADETİ	360
AÇIKLAMA	İnce Uzun Pimli 15A 1NO + 1NC



Birim Fiyat USD / Ad.	2.70
SİPARİŞ KODU	6814
ÜRÜN KODU	AZ - 15GW - B
KUTU ADET	20
KOLİ ADETİ	360
AÇIKLAMA	Uzun Palet 15A 1NO + 1NC

AZ SERİSİ MİKRO SWITCH

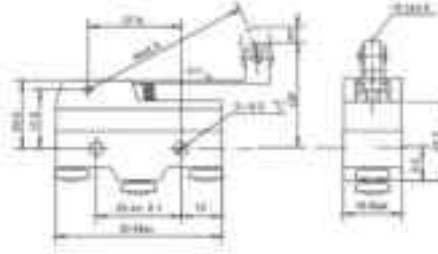

Birim Fiyat USD / Ad.	3.10
SİPARİŞ KODU	6815
ÜRÜN KODU	AZ - 15GW2 - B
KUTU ADET	20
KOLİ ADETİ	360
AÇIKLAMA	Uzun Palet Metal Makaralı 15A 1NO + 1NC

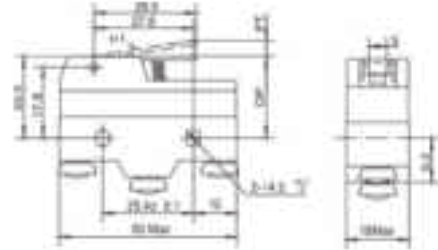

Birim Fiyat USD / Ad.	2.70
SİPARİŞ KODU	6817
ÜRÜN KODU	AZ - 15GW21 - B
KUTU ADET	20
KOLİ ADETİ	360
AÇIKLAMA	Kısa Paletli 15A 1NO + 1NC

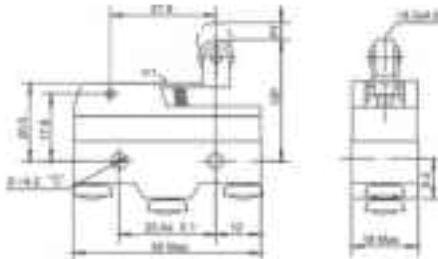

Birim Fiyat USD / Ad.	3.10
SİPARİŞ KODU	6818
ÜRÜN KODU	AZ - 15GW22 - B
KUTU ADET	20
KOLİ ADETİ	360
AÇIKLAMA	Kısa Metal Makaralı 15A 1NO + 1NC

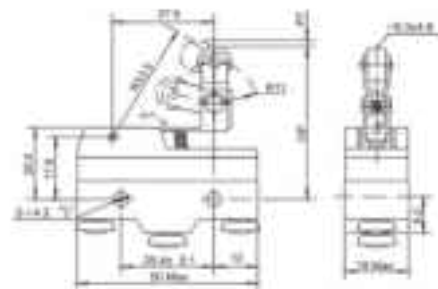

Birim Fiyat USD / Ad.	3.20
SİPARİŞ KODU	6819
ÜRÜN KODU	AZ - 15GW2277 - B
KUTU ADET	20
KOLİ ADETİ	360
AÇIKLAMA	Tahrikli Metal Makaralı 15A 1NO + 1NC

AZ SERİSİ MİKRO SWITCH

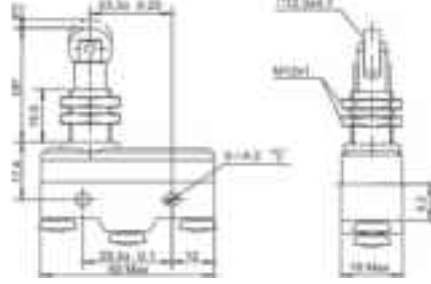

Birim Fiyat USD / Ad.	4.00
SİPARİŞ KODU	6820
ÜRÜN KODU	AZ - 15GQ22 - B
KUTU ADET	20
KOLİ ADETİ	360
AÇIKLAMA	Dikey Metal Makaralı 15A 1NO + 1NC

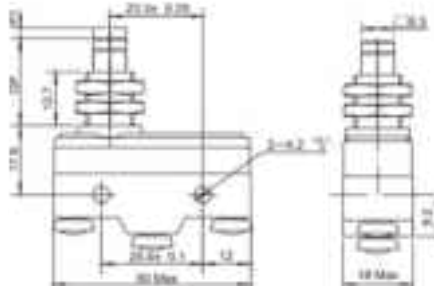

Birim Fiyat USD / Ad.	3.80
SİPARİŞ KODU	6821
ÜRÜN KODU	AZ - 15GQ - B
KUTU ADET	20
KOLİ ADETİ	360
AÇIKLAMA	Kalın Kısa Metal Pimli 15A 1NO + 1NC

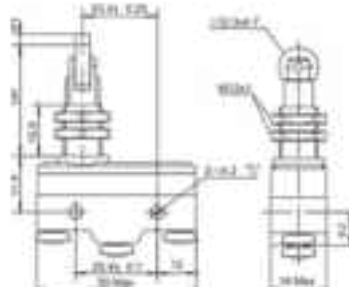

Birim Fiyat USD / Ad.	4.00
SİPARİŞ KODU	6822
ÜRÜN KODU	AZ - 15GQ21 - B
KUTU ADET	20
KOLİ ADETİ	360
AÇIKLAMA	Yan Dik Metal Makaralı 15A 1NO + 1NC

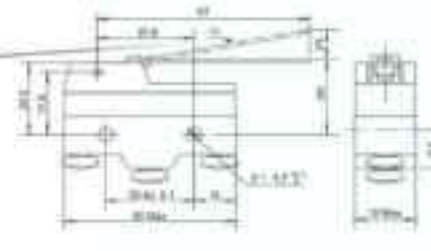

Birim Fiyat USD / Ad.	3.00
SİPARİŞ KODU	6823
ÜRÜN KODU	AZ - 15HW24 - B
KUTU ADET	20
KOLİ ADETİ	360
AÇIKLAMA	Uzun Tel Palet 15A 1NO + 1NC

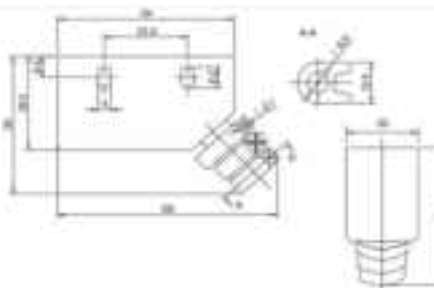

Birim Fiyat USD / Ad.	0.60
SİPARİŞ KODU	6824
ÜRÜN KODU	XAP - Y
KUTU ADET	20
KOLİ ADETİ	360
AÇIKLAMA	Koruma Kapağı

GMS SERİSİ MİKRO SWITCH



Birim Fiyat USD / Ad.	1.00		
SİPARİŞ KODU	6830	ÜRÜN KODU	GMS - 100C
KUTU ADET	100	KOLİ ADET	1.800
AÇIKLAMA	10 Amper Plastik Pimli Mikro Switch		



Birim Fiyat USD / Ad.	1.00		
SİPARİŞ KODU	6831	ÜRÜN KODU	GMS - 101C
KUTU ADET	100	KOLİ ADET	1.800
AÇIKLAMA	10 Amper Orta Kollu Mikro Switch		



Birim Fiyat USD / Ad.	1.00		
SİPARİŞ KODU	6832	ÜRÜN KODU	GMS - 102C
KUTU ADET	100	KOLİ ADET	1.800
AÇIKLAMA	10 Amper Kısa Kollu Mikro Switch		



Birim Fiyat USD / Ad.	1.00		
SİPARİŞ KODU	6833	ÜRÜN KODU	GMS - 103C
KUTU ADET	100	KOLİ ADET	1.800
AÇIKLAMA	10 Amper Uzun Kollu Metal Makaralı Mikro Switch		



Birim Fiyat USD / Ad.	1.00		
SİPARİŞ KODU	6834	ÜRÜN KODU	GMS - 104C
KUTU ADET	100	KOLİ ADET	1.800
AÇIKLAMA	10 Amper Kısa Kollu Metal Makaralı Mikro Switch		



Birim Fiyat USD / Ad.	1.00		
SİPARİŞ KODU	6835	ÜRÜN KODU	GMS - 105C
KUTU ADET	100	KOLİ ADET	1.800
AÇIKLAMA	10 Amper Uzun Kollu Mikro Switch		



Birim Fiyat USD / Ad.	1.00		
SİPARİŞ KODU	6836	ÜRÜN KODU	GMS - 106C
KUTU ADET	100	KOLİ ADET	1.800
AÇIKLAMA	10 Amper Kıvrık Kollu Mikro Switch		



GÜVEN
ELEKTRİK ELEKTRONİK LTD. ŞTİ.

AYAK PEDALLARI



www.guvenelektrik.com.tr



AYAK PEDALLARI

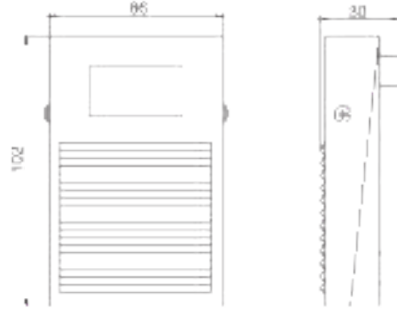

Birim Fiyat USD / Ad.	5.00	5.30
SİPARİŞ KODU	6900	6901
ÜRÜN KODU	AP - 1	
KUTU ADET	1	
KOLİ ADETİ	60	
AÇIKLAMA	Metal Döküm Pedal 1 mt Kablolu 2 mt Kablolu	

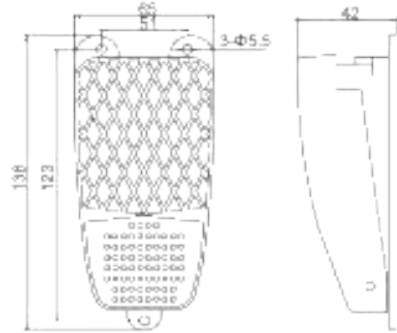

Birim Fiyat USD / Ad.	7.20
SİPARİŞ KODU	6902
ÜRÜN KODU	AP - 2
KUTU ADET	1
KOLİ ADETİ	60
AÇIKLAMA	Alüminyum Döküm Pedal 1mt Kablolu

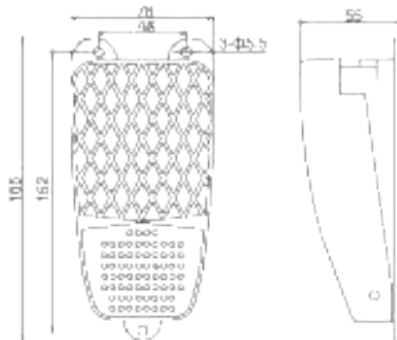

Birim Fiyat USD / Ad.	9.20
SİPARİŞ KODU	6903
ÜRÜN KODU	AP - 3
KUTU ADET	1
KOLİ ADETİ	40
AÇIKLAMA	Alimünyum Döküm Pedal 1mt Kablolu

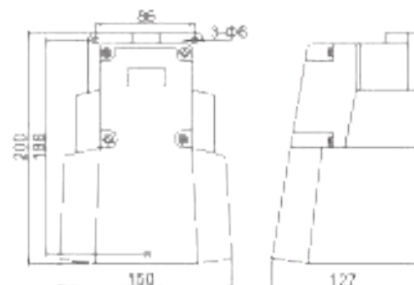

Birim Fiyat USD / Ad.	23.00
SİPARİŞ KODU	6904
ÜRÜN KODU	AP - 9
KUTU ADET	1
KOLİ ADETİ	12
AÇIKLAMA	Metal Döküm Pedal



GÜVEN
ELEKTRİK ELEKTRONİK LTD. ŞTİ.

“Başarılar Karşılıklı Güven’e Bağlıdır.”



MERKEZ

İkitelli Organize Sanayi Bölgesi
Mutsan Sanayi Sitesi M12 Blok No:52-54 Başakşehir/İstanbul
Tel: (0212) 485 05 40 Faks: (0212) 486 05 61



ŞUBE

Okçu Musa Cad. Menevşe İşhanı No: 22/199-200 Karaköy/İstanbul
Tel: (0212) 361 69 61 Faks: (0212) 361 69 63